

EXAIR®

MANUFACTURING INTELLIGENT COMPRESSED AIR® PRODUCTS SINCE 1983



COAT



CONSERVE



COOL



CONVEY



CLEAN



NEW

- Ion Air Cannon... pg. 108
- Ion Air Gun..... pg. 110

30
CATALOG

TECHHELP
1-800-903-9247
DIRECT

YOU REQUESTED THIS CATALOG AND PRICE LIST.
PLEASE SEE MAILING LABEL ON BACK COVER.

Stay up to date by visiting our website and take advantage of the information and services we didn't have room to display in this catalog.

EXAIR.com®

The digital home of Intelligent Compressed Air® products for industry



Where you can

- **Chat live** with our problem solving, technical expert Application Engineers
- **Watch product videos** to learn more about the features and benefits of our engineered products
- Quickly **order online** with a purchase order or credit card (US & Canada)
- **Access product presentation slides** you can use to educate others
- **Find International Distributors** all across the world



Access our Knowledge Base to

- **Download 3D models** and CAD drawings in multiple formats to place into your drawings
- **Calculate air savings and ROI** to see how quickly EXAIR products will pay off
- Search our **Case Study Library & Applications** database and become familiar with how our products solve problems
- **Use our product FAQ's** for quick access to our most common questions
- Learn about our free Efficiency Lab service and use it to **determine air and money savings** you can achieve when installing EXAIR engineered solutions
- Collect compressed air data and pipe sizing recommendations
- **Find Flow, Force and Heat conversions**



Visit our PDF library and download

- Electronic files of **the entire catalog** or individual sections
- **Installation and Maintenance Guides** on every EXAIR product
- Our current **price list** to have all product prices in one convenient location
- EXAIR's **Air Nozzle Blowoff Guide** to see the details on our enormous selection of sizes, materials and performance options



Follow our blog for 5 new entries a week and learn

- Details and installations of widely varied applications
- The methodology and results of critical mathematical formulas which help determine money savings, air savings, performance benefits and more
- New product releases before they reach our catalog or website
- More about EXAIR, our team and community involvement
- **Go to** blog.exair.com

Make social connections

- Watch **over 80 videos** on EXAIR's YouTube Channel and see product features and benefits, applications, Tips & Tricks, How-to, our team members, or be entertained by Professor Penurious!
- **Follow our Company on Twitter @EXAIR** or our Application Engineers and learn more about promotions, updates on manufacturing, engineering and international industry perspective.



- **Connect with us on Facebook** at facebook.com/exair or follow us on Google+



Not on a PC? Our website is mobile friendly

Terms and Conditions 4
 Efficiency Lab 5



EXAIR Optimization

Minimize compressed air use and detect wasteful leaks

6 Steps to Optimization 6
 Electronic Flow Control 7
 Digital Sound Level Meter 10
 Ultrasonic Leak Detector 11
 Digital Flowmeter 13



Air Knives

Blowoff, clean, dry and cool with less noise and air consumption

Super Air Knife 15
 Compare Blowoffs 18
 Explanation of Materials 21
 Universal Air Knife Mounting System 24
NEW Plumbing Kits 24
 Long Super Air Knife 26
 Standard Air Knife 28
 Full-Flow Air Knife 31



Air Wipes

Blowoff, dry, clean and cool pipe, cable, extruded shapes and hose

Super Air Wipes 33
 Standard Air Wipes 37



Air Amplifiers

Vent, exhaust, cool, dry and clean - with no moving parts

Super Air Amplifiers 41
 Adjustable Air Amplifiers 45



Air Nozzles and Jets

Reduce noise levels and air costs on blowoff operations

Air Nozzles 47
 Air Nozzle Comparison Chart 49
 Super Air Nozzles 50
 Flat Super Air Nozzles 52
 Back Blow Air Nozzles 54
 Safety Air Nozzles 55
NEW Air Jets 56
 High Force Air Nozzles 58
 High Force Air Nozzle Comparison Chart 58
 High Force Flat Super Air Nozzles 58
 High Force Super Air Nozzles 58
 Super Air Nozzle Clusters 62
 Stay Set Hoses 63
 Swivel Fittings 63
 Blowoff Systems 64



Atomizing Nozzles

All stainless steel construction for durability and corrosion resistance

1/4 NPT Atomizing Nozzles 66
 Internal Mix Narrow Angle Round Atomizing Nozzles 66
 Internal Mix Wide Angle Round Atomizing Nozzles 67
 Internal Mix Flat Fan Atomizing Nozzles 68
 Internal Mix Deflected Flat Fan Atomizing Nozzles 69
 Internal Mix 360° Hollow Circular Atomizing Nozzles 69
 External Mix Round Atomizing Nozzles 70

Atomizing Nozzles continued

External Mix Narrow Angle Flat Fan Atomizing Nozzles 71
 External Mix Wide Angle Flat Fan Atomizing Nozzles 72
 Siphon Fed Round Atomizing Nozzles 73
 Siphon Fed Flat Fan Atomizing Nozzles 74
 1/2 NPT Atomizing Nozzles 75
 Internal Mix Narrow Angle Round Atomizing Nozzles 75
 Internal Mix Wide Angle Round Atomizing Nozzles 76
 Internal Mix Flat Fan Atomizing Nozzles 77
 Internal Mix 360° Hollow Circular Atomizing Nozzles 78
 External Mix Narrow Angle Flat Fan Atomizing Nozzles 79
 Siphon Fed Round Atomizing Nozzles 80



No Drip Atomizing Nozzles

Eliminate drips to conserve valuable liquids and improve product finishes.

1/4 NPT No Drip Atomizing Nozzles 82
 No Drip Internal Mix Narrow Angle Round Atomizing Nozzles 82
 No Drip Internal Mix Wide Angle Round Atomizing Nozzles 82
 No Drip Internal Mix Flat Fan Atomizing Nozzles 82
 No Drip Internal Mix Deflected Flat Fan Atomizing Nozzles 82
 No Drip Internal Mix 360° Hollow Circular Atomizing Nozzles 82
 No Drip External Mix Round Atomizing Nozzles 83
 No Drip External Mix Narrow Angle Flat Fan Atomizing Nozzle 83
 No Drip External Mix Wide Angle Flat Fan Atomizing Nozzle 83
 No Drip Siphon Fed Round Atomizing Nozzles 83
 No Drip Siphon Fed Flat Fan Atomizing Nozzles 83
 1/2 NPT No Drip Atomizing Nozzles 82
 No Drip Internal Mix Narrow Angle Round Atomizing Nozzles 82
 No Drip Internal Mix Wide Angle Round Atomizing Nozzles 82
 No Drip Internal Mix Flat Fan Atomizing Nozzles 82
 No Drip Internal Mix 360° Hollow Circular Atomizing Nozzles 82
 No Drip External Mix Narrow Angle Flat Fan 83
 No Drip Siphon Fed Round Atomizing Nozzles 83
 Droplet Size/Spray Angle Information 84

85



Safety Air Guns

Safety air guns use engineered air nozzles for high performance

Chip Shields	86
Precision Safety Air Guns	87
Soft Grip Safety Air Guns	87
Heavy Duty Safety Air Guns	90
Back Blow Safety Air Guns	91
Super Blast Safety Air Guns	92

94



Static Eliminators

Eliminate static electricity, dust and shock hazard

Super Ion Air Knife	96
Static Meter	98
Standard Ion Air Knife	102
Ionizing Bars	104
Super Ion Air Wipes	106
Ion Air Cannon	108
Ion Air Gun	110
Ion Air Jet/Stay Set Ion Air Jet	112
Ionizing Point	114
Power Supplies	115

116

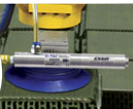

E-Vac® Vacuum Generators

Vacuums for lifting, clamping, mounting and placement

How to Build an E-Vac System	117
In-Line	118
Adjustable	121
Vacuum Cups	123

127



Air Operated Conveyors

Convey parts, materials and waste - with no moving parts

130 Line Vac	127
131 Threaded Line Vac	133
130 Heavy Duty Line Vac	136
Light Duty Line Vac	138

140



Industrial Housekeeping

Reliable vacuums for chip removal, liquid transfer and cleaning

Reversible Drum Vac	140
High Lift Reversible Drum Vac	142
Chip Trapper	144
High Lift Chip Trapper	146
Chip Vac	148
Heavy Duty Dry Vac	150
150 Heavy Duty HEPA Vac	152
Vac-u-Gun	154
Deep Hole Vac-u-Gun	156
Air Stik Window	158

159



Vortex Tubes & Spot Cooling

Cold air for industrial spot cooling problems

Vortex Tubes	159
Adjustable Spot Cooler	167
Mini Cooler	170

171



Cold Gun Aircoolant Systems

Cool machining operations with clean, cold air

175



Cabinet Cooler® Systems

Cool and purge NEMA 12, 4 and 4X electrical control panels

How it Works	176
Selecting the Right Model	176
Special Duty Cabinet Coolers	177
Calculating Heat Load	179
Cabinet Cooler Sizing Guide	180
NEMA 12 Models	182
NEMA 4 Models	183
NEMA 4X Models	184
Cabinet Cooler System Accessories	185

186



Accessories

Mufflers, filters, regulators, valves, swivel fittings and more

Filters	186
Regulators	187
Silencing Mufflers	188
Valves, Swivels, Thermostats	190
Magnetic Bases, Stay Sets, Hoses	191
Air Hoses	191
Fittings	192
Receiver Tank	192

ORDER BY
3PM
SHIPS SAME DAY

Catalog item orders received before 3 pm EDT/ EST are generally shipped from Cincinnati, Ohio on the same day. You can expect delivery within 1-4 days depending on your location.

Terms and Conditions (U.S. and Canada Only)

Terms: Net 30 days upon credit approval, Visa, MasterCard, Discover and American Express.

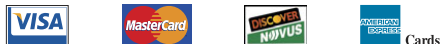

ICC (International Chamber of Commerce) INCOTERM 2010: EX WORKS (EXAIR Corporation, 11510 Goldcoast Dr., Cincinnati, Ohio 45249, USA)

Delivery: All cataloged products are shipped from stock, via U.P.S. within 24 hours after receipt of order. Priority shipment is available upon request.

Ordering: Call 1-800-903-9247 or +1-513-671-3322 Worldwide
8:00 a.m. to 5:00 p.m. ET (Mon. - Fri.)

Fax toll free 1-866-329-3924 or
+1-513-671-3363 Worldwide

E-mail: orders@exair.com
www.exair.com (secure web site)

Remit to address (payments only):

EXAIR Corporation
Location 00766
Cincinnati, Ohio 45264-0766

Tax: Sales and use tax, where applicable, are not included.

OSHA and CE Compliance: EXAIR compressed air products comply with OSHA's Safety Requirements, the EU General Product Safety Directive (2001/95/EC) and meet the noise limitation requirements of the EU Machinery Directive (2006/42/EC). EXAIR's Electronic Flow Control and Electronic Temperature Control meet the low voltage standards of the EU Low Voltage Directive (2006/95/EC). Some EXAIR products display the CE mark where there are applicable directives. All sound level measurements are taken at 3 feet away.

RoHS: Electrical portions of EXAIR's static eliminators, EFC, ETC, solenoid valves, and thermostats comply with the RoHS (Restriction of Hazardous Substances) Directive 2002/95/EC, including the amendment outlined in the European Commission decision L 214/65.

Reach: Per Regulation (EC) No 1907/2006 Title I, Article 3, paragraph 3, the European Union has recently enacted legislation to register chemicals and substances imported into the EU to ensure a high level of protection of human health and the environment.

Per Title II, Article 7, paragraph 1, articles (products) must be registered when a substance is intended to be released under normal or reasonably foreseeable conditions of use and it is present in those articles in quantities totaling over 1 metric ton per producer or importer per year. Registration of EXAIR products is not required since they do not contain substances that are intentionally released.

Conflict Mineral Free: Look for this symbol to designate conflict mineral free products throughout our catalog. EXAIR supports Section 1502 of the Dodd-Frank Wall Street Reform and Consumer Protection Act and we are committed to compliance with the conflict minerals rule in order to curb the illicit trade of tin, tantalum, tungsten and gold in the DRC region. EXAIR is using the CMRT 3.02 template to document our supply chain and commitment to conflict free products.

Copyright Restrictions: The content of the EXAIR Catalog, including all photos, graphics, drawings and arrangements are proprietary to EXAIR Corporation and are protected by the United States and international copyright and trademark laws. You are authorized to use the contents of the EXAIR Catalog for personal use or as it relates to your role as a current or prospective customer of EXAIR. The contents of this catalog may not be copied or modified for any type of publication or distribution without the prior written consent of EXAIR Corporation. The content of the EXAIR Catalog is the intellectual property solely of the EXAIR Corporation with no rights transferred to other parties. No part of this catalog may be reproduced for any commercial purposes without the express authorization in writing by the EXAIR Corporation.

Trademarks: "EXAIR.com", "EXAIR", "Cabinet Cooler", "E-Vac", "Intelligent Compressed Air", and "Compressed Air Intelligence" are registered trademarks of the EXAIR Corporation. The EXAIR logo, product names, designs and descriptive phrases are trademarked by EXAIR Corporation. These trademarks may not be used without prior written permission of the EXAIR Corporation.

EFC, Digital Flowmeter, Digital Sound Level Meter, High Power Cold Gun, Super Air Knife, Standard Air Knife, Full-Flow Air Knife, Air Cannon, Super Air Amplifier, Adjustable Air Amplifier, Super Air Nozzle, Micro Air Nozzle, High Power Safety Air Nozzle, Stay Set Hose, Super Blast Safety Air Gun, Super Air Wipe, Standard Air Wipe, Super Ion Air Knife, Standard Ion Air Knife, Super Ion Air Wipe, Ion Air Cannon, Ion Air Gun, Ion Air Jet, Ionizing Point, Stay Set Ion Air Jet, Line Vac, Chip Vac, Heavy Duty Dry Vac, Heavy Duty HEPA Vac, Reversible Drum Vac, High Lift Reversible Drum Vac, Chip Trapper, High Lift Chip Trapper, Vac-u-Gun, Deep Hole Vac-u-Gun, Air Disk, Air Stick, Mini Cooler, Cold Gun Aircontrol System, and ETC are trademarks of EXAIR Corporation.



Intelligent Compressed Air® products are identified throughout this catalog that can help your plant save tens of thousands of dollars over the course of a single year. *The Best Practices for Compressed Air Systems* manual published by the Compressed Air Challenge® recommends products like the Super Air Knife®, Super Air Amplifier®, and the family of Super Air Nozzles® for energy conservation. Many of the products shown offer unique ways to solve common industrial problems using compressed air. Compressed Air Challenge is a registered trademark of Compressed Air Challenge, Inc.



EXAIR has partnered with Energy Star, a voluntary program of the U.S. Department of Energy and the Environmental Protection Agency. Energy Star offers energy efficient solutions to help save money while protecting the environment for future generations. EXAIR has implemented improved energy management practices and technologies throughout our facility, including energy efficient lighting, HVAC systems, and electronic thermostats. EXAIR's participation in this program underscores our commitment to conserving energy.

EXAIR products are subject to ongoing development. Specifications are subject to change without notice.

Some products in this catalog are covered by U.S. Patent #5402938, #8153001, #8268179, and #9156045, and others may be U.S. Patent Pending.

Copyright © 2016 EXAIR Corporation. All Rights Reserved.

Technical Assistance: Please call our Application Engineering Department, 1-800-90-EXAIR (1-800-903-9247), or e-mail at techhelp@exair.com.

Warranty: 5 Year "Built To Last" Warranty against defects in workmanship and materials on all compressed air products*. Defective products must be returned freight prepaid for repair or replacement at our option. This warranty applies under conditions of normal use, but does not apply to defects that result from intentional damage, negligence, unreasonable use, wear or exposure.

Built to Last 5 Year WARRANTY

*5 Year Warranty applies to compressed air products only.

A 1 Year Warranty applies to all accessories and electrically powered products.

EXAIR's Unconditional Guarantee:

Extends to all U.S. and Canadian customers and includes invoiced U.P.S. Ground Service shipping charges. Products returned after the 30 day guarantee period are subject to a 15% restocking charge. Products must be returned freight prepaid.

EXAIR Corporation

11510 Goldcoast Dr.
Cincinnati, Ohio 45249-1621
Phone Number: (513) 671-3322
Fax Number: (513) 671-3363
E-mail: techhelp@exair.com
Web Site: www.exair.com



EXAIR®

EFFICIENCYLAB



EXAIR's Intelligent Compressed Air® products vs Your current installation

How does the Efficiency Lab work?

Our Efficiency Lab service begins with receiving a sample of the product(s) you currently use for your application. One of our qualified Application Engineers will use calibrated testing equipment to compare the performance of your existing product(s) to an EXAIR engineered solution. These tests will determine air consumption, noise levels and force. The test results will then be published in a comprehensive report, which includes a cost savings analysis, and be provided to you. For most applications, EXAIR products can help you improve application efficiency AND typically pay for themselves in a matter of weeks.

How can I get a product tested for free?

To participate in our FREE Efficiency Lab please contact one of our Application Engineers and get the details about sending us your product(s).

You may reach an application Engineer by phone at (800) 903-9247 or (513) 671-3322. You can send an email to lab@exair.com or visit our website and take advantage of our live help at www.exair.com.

EXAIR's FREE Efficiency Lab service determines how much air and dollar savings you will achieve by installing one of our Intelligent Compressed Air products.

Unable to send your product to EXAIR's Efficiency Lab?

If it is not possible to send us your product, we have a one page Product Efficiency Survey on our website (www.exair.com/labdoc.htm) which will provide us the details about a current inefficient compressed air application. Fill in the information and click submit. You will hear from one of our Application Engineers within 3 business days.

Okay, so what is the fine print?

This offer is available to all customers in the U.S. and Canada only. Some restrictions may apply.

What about confidentiality?

Yes, EXAIR will keep the results of our Efficiency Lab test and report confidential unless given permission to share that information with others.

Products must be shipped to EXAIR freight prepaid. EXAIR will pay the return shipping via UPS ground.

Vortex Tubes

Cold air to -50°F (-46°C) from your compressed air supply — with no moving parts!



What Is A Vortex Tube?

A low cost, reliable, maintenance free solution to a variety of industrial spot cooling problems. Using an ordinary supply of compressed air as a power source, vortex tubes create two streams of air, one hot and one cold, **with no moving parts**. Vortex tubes can produce:

- Temperatures from -50° to +260°F (-46° to +127°C)
- Flow rates from 1 to 150 SCFM (28 to 4,248 SLPM)
- Refrigeration up to 10,200 Btu/hr. (2,570 Kcal/hr.)

Temperatures, flows and cooling power are adjustable over a wide range using the control valve on the hot end exhaust.

Why EXAIR Vortex Tubes?

EXAIR Vortex Tubes are constructed of **stainless steel**. The wear resistance of stainless steel, as well as its resistance to corrosion and oxidation, assures that EXAIR Vortex Tubes will provide years of reliable, maintenance-free operation.



A 1/4 ton of refrigeration in the palm of your hand!

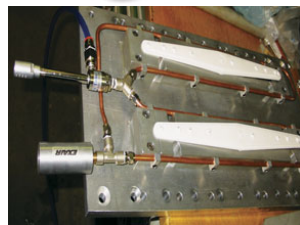

A Model 3225 Vortex Tube keeps plastic dishwasher arms cool during ultrasonic welding.



Special high temperature vortex tubes keep a boroscope lens cool while inserted into a 1200°F (650°C) boiler porthole.

Applications

- Cooling electronic controls
- Cooling machining operations
- Cooling CCTV cameras
- Setting hot melts
- Cooling soldered parts
- Cooling gas samples
- Electronic component cooling
- Cooling heat seals
- Cooling environmental chambers

Advantages

- No moving parts
- No electricity or chemicals
- Small, lightweight
- Low cost
- Maintenance free
- Instant cold air
- Durable - stainless steel
- Adjustable temperature
- Interchangeable generators



A pair of medium vortex tubes cool a solenoid coil after a welding operation.

Vortex Tubes

How A Vortex Tube Works

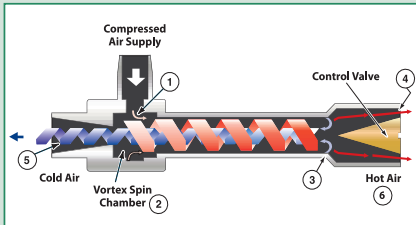

Compressed air, normally 80-100 PSIG (5.5 - 6.9 BAR), is ejected tangentially (1) through a generator into the vortex spin chamber (2). At up to 1,000,000 RPM, this air stream revolves toward the hot end (3) where some escapes through the control valve (4). The remaining air, still spinning, is forced back through the center of this outer vortex. The inner stream gives off kinetic energy in the form of heat to the outer stream and exits the vortex tube as cold air (5). The outer stream exits the opposite end as hot air (6). There is a detailed discussion of vortex tube history and theory later on page 165 in this section.

Controlling Temperature And Flow In A Vortex Tube

Cold airflow and temperature are easily controlled by adjusting the slotted valve in the hot air outlet. **Opening the valve decreases the cold airflow and the cold air temperature. Closing the valve increases the cold airflow and the cold air temperature.** The percentage of air directed to the cold outlet of the vortex tube is called the “cold fraction”. In most applications, a cold fraction of 80% produces a combination of cold flow rate and temperature drop that maximizes refrigeration, or Btu/hr. (Kcal/hr.), output of a vortex tube. While low cold fractions (less than 50%) produce lowest temperatures, cold airflow volume is sacrificed to achieve them.

Most industrial applications, i.e., process cooling, part cooling, chamber cooling, require maximum refrigeration and utilize the 32XX series Vortex Tube. Certain “cryogenic” applications, i.e., cooling lab samples, circuit testing, are best served by the 34XX series Vortex Tube.

Setting a vortex tube is easy. Simply insert a thermometer in the cold air exhaust and set the temperature by adjusting the valve at the hot end. **Maximum refrigeration (80% cold fraction) is achieved when cold air temperature is 50°F (28°C) below compressed air temperature.**

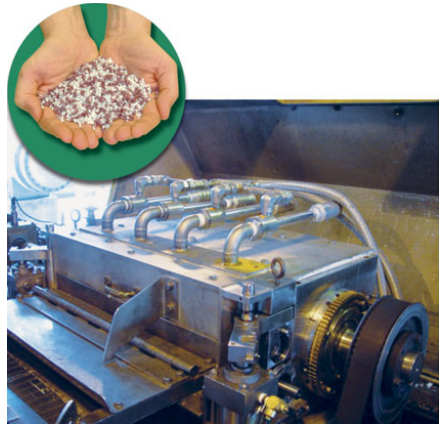

(4) Model 3250 Vortex Tubes cool the cutting knives in this pelletizer to prevent irregular shapes.

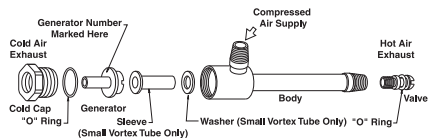

Model 3930 EXAIR Cooling Kit

If you are unsure of your flow and temperature requirements, EXAIR recommends the purchase of an EXAIR Cooling Kit. It contains a vortex tube, cold air muffler, air line filter and all generators required to experiment with the full range of airflows and temperatures.

Selecting The Right Vortex Tube

EXAIR Vortex Tubes are available in three sizes. Each size can produce a number of flow rates, as determined by a small internal part called a **generator**. If Btu/hr. (Kcal/hr.) requirements, or flow and temperature requirements are known, simply select the appropriate vortex tube according to the specification information shown below or the performance charts shown on the following page. Keep in mind that the **vortex generators are interchangeable**. If, for example, a Model 3215 Vortex Tube does not provide sufficient cooling, you need only change generators within the vortex tube to upgrade the flow rate from 15 to 25, 30 or 40 SCFM (425 to 708, 850 or 1,133 SLPM). Generator part numbers are shown in the "Accessories" listing on page 166.

Vortex Tube Dimensions

Small

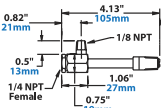

With Mufflers

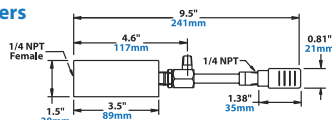

Medium

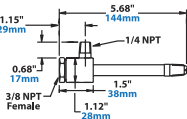

With Mufflers

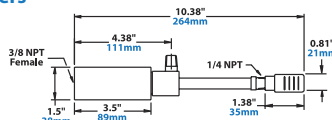

Large

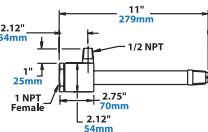

With Mufflers

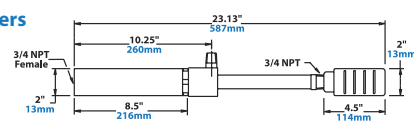

Vortex Tube Specifications

32XX series Vortex Tubes optimize temperature drop and airflow to **produce maximum cooling power or Btu/hr. (Kcal/hr.)**. Specify 32XX series Vortex Tubes for most general cooling applications.

34XX series Vortex Tubes provide **lowest cold air temperatures, but at low cold airflow (when less than a 50% cold fraction is used)**. Specify 34XX series Vortex Tubes only where temperatures below 0°F (-18°C) are desired.

32XX Series Vortex Tube Specifications							34XX Series Vortex Tube Specifications						
Model	SCFM*	SLPM*	Btu/hr.**	Kcal/hr.**	SIZE	dBA***	Model	SCFM*	SLPM*	Btu/hr.**	Kcal/hr.**	SIZE	dBA***
3202	2	57	135	34	Small	68	3402	2	57	-----	-----	Small	67
3204	4	113	275	69	Small	70	3404	4	113	-----	-----	Small	69
3208	8	227	550	139	Small	76	3408	8	227	-----	-----	Small	75
3210	10	283	650	164	Medium	80	3410	10	283	-----	-----	Medium	78
3215	15	425	1,000	252	Medium	81	3415	15	425	-----	-----	Medium	80
3225	25	708	1,700	428	Medium	82	3425	25	708	-----	-----	Medium	82
3230	30	850	2,000	504	Medium	84	3430	30	850	-----	-----	Medium	84
3240	40	1,133	2,800	706	Medium	88	3440	40	1,133	-----	-----	Medium	87
3250	50	1,416	3,400	857	Large	94	3450	50	1,416	-----	-----	Large	93
3275	75	2,124	5,100	1,285	Large	96	3475	75	2,124	-----	-----	Large	96
3298	100	2,832	6,800	1,714	Large	96	3498	100	2,832	-----	-----	Large	96
3299	150	4,248	10,200	2,570	Large	97	3499	150	4,248	-----	-----	Large	96

* SCFM (SLPM) at 100 PSIG (6.9 BAR) Inlet Pressure

** Btu/hr. (Kcal/hr.) Cooling Capacity at 100 PSIG (6.9 BAR)

*** Noise levels taken with hot and cold mufflers installed.

* SCFM (SLPM) at 100 PSIG (6.9 BAR) Inlet Pressure

** Not Applicable. 34XX series Vortex Tubes are not normally used in air conditioning applications.

*** Noise levels taken with hot and cold mufflers installed.

Vortex Tube Performance

The **Vortex Tube Performance Charts** below give approximate temperature drops (and rises) **from inlet air temperature** produced by a vortex tube set at each cold fraction. Assuming no fluctuation of inlet temperature or pressure, a vortex tube will reliably maintain temperature within $\pm 1^\circ\text{F}$.

Pressure Supply		Cold Fraction %						
PSIG	20	30	40	50	60	70	80	
20	62	60	56	51	44	36	28	
	15	25	36	50	64	83	107	
40	88	85	80	73	63	52	38	
	21	35	52	71	92	117	147	
60	104	100	93	84	73	60	46	
	24	40	59	80	104	132	166	
80	115	110	102	92	80	66	50	
	25	43	63	86	113	143	180	
100	123	118	110	100	86	71	54	
	26	45	67	90	119	151	191	
120	129	124	116	104	91	74	55	
	26	46	69	94	123	156	195	

Numbers in shaded area give temperature drop of cold air, °F.
Numbers in white area give temperature rise of hot air, °F.

Pressure Supply		Cold Fraction % (METRIC)						
BAR	20	30	40	50	60	70	80	
1.4	34.4	33.3	31.1	28.3	24.4	20.0	15.6	
	8.3	13.9	20.0	28.3	35.6	46.1	59.4	
2	40.9	39.6	37.1	33.8	29.2	24.0	18.1	
	9.8	16.4	24.0	33.3	42.6	54.6	69.5	
3	50.4	48.7	45.7	41.6	36.0	29.7	21.9	
	12.0	19.9	29.6	40.3	52.3	66.5	83.5	
4	56.9	54.7	50.9	46.1	40.0	32.9	25.1	
	13.2	21.9	32.4	43.9	57.1	72.5	91.2	
5	61.6	59.0	54.8	49.4	43.0	35.4	26.9	
	13.7	23.3	34.2	46.5	60.9	77.2	97.1	
6	65.4	62.7	58.2	52.7	45.6	37.6	28.6	
	14.1	24.3	35.8	48.6	63.9	81.0	102.1	
7	68.6	65.8	61.4	55.7	48.0	39.6	30.0	
	14.4	25.1	37.3	50.2	66.3	84.2	106.3	
8	71.1	68.2	63.8	57.3	50.0	40.8	30.4	
	14.4	25.4	38.1	51.8	67.9	86.1	107.9	

Numbers in shaded area give temperature drop of cold air, °C.
Numbers in white area give temperature rise of hot air, °C.

Back Pressure: The performance of a vortex tube deteriorates with back pressure on the cold air exhaust. Low back pressure, up to 2 PSIG (.1 BAR), will not change performance. 5 PSIG (.3 BAR) will change performance by approximately 5°F (2.8°C).

Filtration: The use of clean air is essential, and filtration of 25 microns or less is recommended. EXAIR filters contain a 5 micron element and are properly sized for flow.

Inlet Air Temperature: A vortex tube provides a temperature drop from supply air temperature (see *Performance Charts* above). Elevated inlet temperatures will produce a corresponding rise in cold air temperatures.

Noise Muffling: EXAIR offers mufflers for both the hot and cold air discharge. Normally, muffling is not required if the cold air is ducted.

Regulation: For best performance, use line pressures of 80 to 110 PSIG (5.5 to 7.6 BAR). Maximum pressure rating is 250 PSIG (17.2 BAR), minimum 20 PSIG (1.4 BAR).

EXAIR Products Using Vortex Tubes

Over the years, the basic vortex tube has been used in virtually hundreds of industrial cooling applications. A few have become so popular as to warrant the development

of an “applied product” designed to suit the specific application. These products include the Adjustable Spot Cooler, Mini Cooler, Cold Gun and Cabinet Coolers that can be found in this catalog.



High Temperatures

High temperature vortex tubes for ambient temperatures above 200°F (93°C) are available. Standard vortex tubes are for ambient temperatures up to 125°F (52°C). Contact an Application Engineer at 1-800-903-9247 for details.

Preset Vortex Tubes

EXAIR can provide vortex tubes preset to any combination of flow and temperature desired. To prevent tampering with the desired setting, a drilled orifice that replaces the adjustable hot valve is available. For more information, please contact an Application Engineer.

Cooling Vacuum Formed Parts

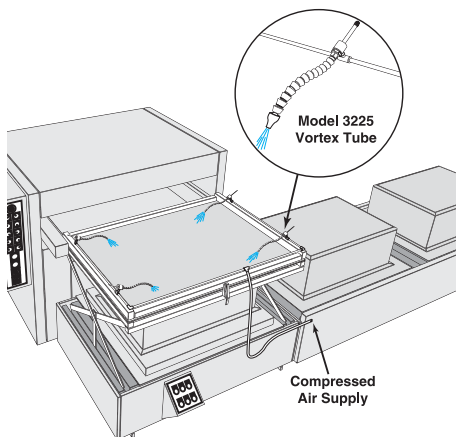

The Problem: A manufacturer of major appliances vacuum forms the plastic interior shell of refrigerators. The deep draw of the plastic and complex geometry left the four corners unacceptably thin. The corners would tear during assembly or bulge when insulation was inserted between the shell and exterior housing, resulting in a high rejection rate.

The Solution: (4) Model 3225 Vortex Tubes were positioned to cool the critical corner areas just prior to forming the plastic sheet. By cooling these areas, less stretching of the plastic occurred which resulted in thicker corners.

Comment: Rejected parts become very costly, especially when expensive materials and slow process times are involved. The cold air from the vortex tube is just the solution for big problems like this one. It can supply "instant" cold air down to -50°F (-46°C) from an ordinary compressed air supply. Along with cooling other vacuum formed parts such as spas, bathtubs, tote pans and waste cans, it is ideal for cooling hot melts, ultrasonic welders, environmental chambers, etc.

This is an ideal application for EXAIR's EFC, an electronic flow control for compressed air, shown on page 7. It reduces air consumption by turning on the compressed air for a preset length of time, when sensing the plastic sheet is in position.

Cooling An Ultrasonic Weld

The Problem: A manufacturer of toothpaste seals the ends of plastic tubes with an ultrasonic welder prior to filling. As heat built up at the sealing jaw of the welder, release of the tubes was delayed. Tubes that were too hot would not seal resulting in a high rate of rejection.

The Solution: A Model 3215 Vortex Tube was used to direct cold air at the jaw of the welder. The cooling was transferred through the metal jaw to the tube seam while in the clamped position.

Process time was reduced and rejected tubes were eliminated.

Comment: It amazes most people that the cooling from a small vortex tube can dramatically improve quality and throughput. The vortex tube is the low cost solution for cooling parts, chambers, heat seals and various processes. They're easy to use, can be adjusted to produce cold air down to -50°F (-46°C) and have no moving parts to wear out.

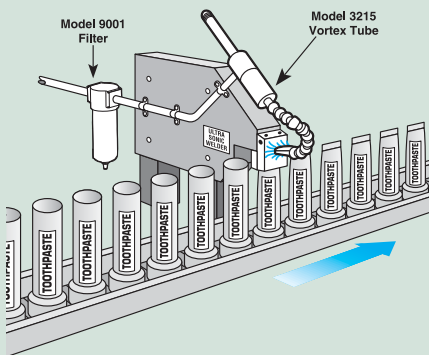

Cooling Blow Molded Fuel Tanks

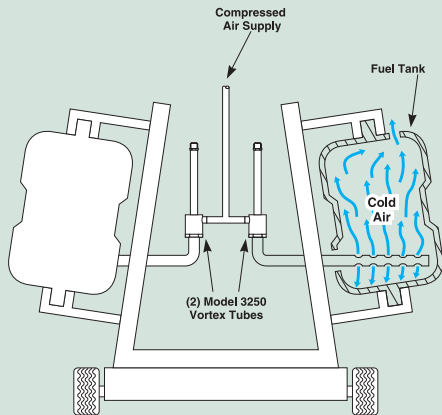

The Problem: Automobile fuel tanks are blow molded, then clamped to a fixture to prevent distortion during the cooling cycle. The cooling time of over 3 minutes required for each tank created a bottleneck in the production process.

The Solution: (2) Model 3250 Vortex Tubes were mounted to the cooling rack and connected to a compressed air line. Cold air produced by the vortex tubes was circulated inside the fuel tanks. **Cooling time was reduced from three minutes to two minutes for each tank, improving productivity by 33%.**

Comment: It's hard to imagine an application better suited to vortex cooling than this one. The vortex tubes' small size and light weight simplified mounting to the cooling rack. No moving parts assured reliability and maintenance-free operation in a hostile environment. Finally, the cold airstream was easily channeled to the fuel tank via the threaded cold air outlet. When the cooling problem includes the need for simplicity, reliability and compact design, a vortex tube is very often the best choice.

Cooling Small Parts After Brazing

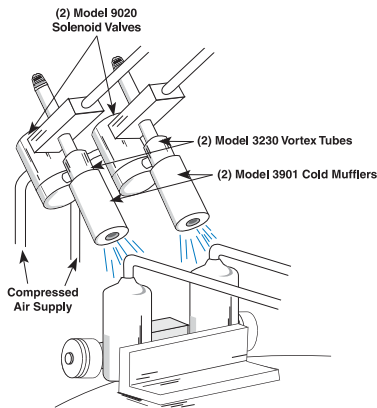

The Problem: Air conditioner parts assembled on an automatic brazing machine must be cooled to handling temperature prior to removal. The machine was capable of brazing up to four hundred pieces per hour. However, the time required for the parts to cool severely limited the production rate. Water cooling was unacceptable from the standpoint of both housekeeping and part contamination.

The Solution: (2) Model 3230 Vortex Tubes (with cold air mufflers installed) were used to blow cold air on the parts after the brazing cycle. The vortex tubes were set at an 80% cold airflow (cold fraction) to produce maximum refrigeration. **The parts were cooled from a brazing temperature of 1,450°F (788°C) to a handling temperature of 120°F (49°C) within 20 seconds, allowing the machine to operate at its maximum production rate.**

Comment: Compared to conventional refrigeration or water cooling, vortex tubes offer a number of advantages: low cost, compact design, inherent reliability and cleanliness. These attributes make vortex tubes the cost effective choice for many small part cooling operations.

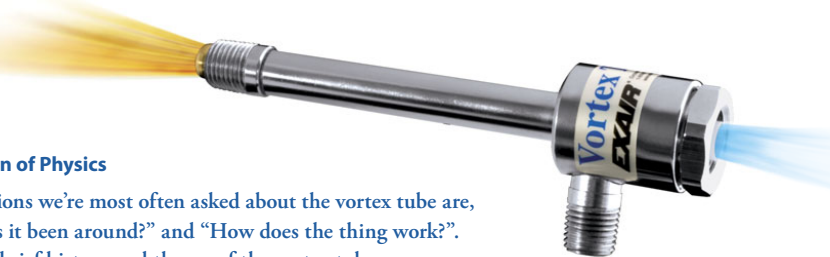

A Phenomenon of Physics

The two questions we're most often asked about the vortex tube are, "How long has it been around?" and "How does the thing work?"

Following is a brief history and theory of the vortex tube.

The vortex tube was invented quite by accident in 1928. George Ranque, a French physics student, was experimenting with a vortex-type pump he had developed when he noticed warm air exhausting from one end, and cold air from the other. Ranque soon forgot about his pump and started a small firm to exploit the commercial potential for this strange device that produced hot and cold air with no moving parts. However, it soon failed and the vortex tube slipped into obscurity until 1945 when Rudolph Hilsch, a German physicist, published a widely read scientific paper on the device.

Much earlier, the great nineteenth century physicist, James Clerk Maxwell, postulated that since heat involves the movement of molecules, we might someday be able to get hot and cold air from the same device with the help of a "friendly little demon" who would sort out and separate the hot and cold molecules of air.

Thus, the vortex tube has been variously known as the "*Ranque Vortex Tube*", the "*Hilsch Tube*", the "*Ranque-Hilsch Tube*", and "*Maxwell's Demon*". By any name, it has in recent years gained acceptance as a simple, reliable and low cost answer to a wide variety of industrial spot cooling problems.

A vortex tube uses compressed air as a power source, has no moving parts, and produces hot air from one end and cold air from the other. The volume and temperature of these two airstreams are adjustable with a valve built into the hot air exhaust. Temperatures as low as -50°F (-46°C) and as high as 260°F (127°C) are possible.

Theories abound regarding the dynamics of a vortex tube.

Here is one widely accepted explanation of the phenomenon:

Compressed air is supplied to the vortex tube and passes through nozzles that are tangent to an internal counterbore. These nozzles set the air in a vortex motion. This spinning stream of air turns 90° and passes down the hot tube in the form of a spinning shell, similar to a tornado. A valve at one end of the tube allows some of the warmed air to escape. What does not escape, heads back down the tube as a second vortex inside the low-pressure area of the larger vortex. This inner vortex loses heat and exhausts through the other end as cold air.

While one airstream moves up the tube and the other down it, both rotate in the same direction at the same angular velocity. That is, a particle in the inner stream completes one rotation in the same amount of time as a particle in the outer stream. However, because of the principle of conservation of angular momentum, the rotational speed of the smaller vortex might be expected to increase. (The conservation principle is demonstrated by spinning skaters who can slow or speed up their spin by extending or drawing in their arms.) But in the vortex tube, the speed of the inner vortex remains the same. Angular momentum has been lost from the inner vortex. The energy that is lost shows up as heat in the outer vortex. Thus the outer vortex becomes warm, and the inner vortex is cooled.

Vortex Tubes

EXAIR Cooling Kits

EXAIR Cooling Kits include a vortex tube, all generators, cold muffler, fitting, tubing and clips to duct cold air, and filter separator.

Model #	Description
3908	Cooling Kit up to 550 Btu/hr. (139 Kcal/hr.), Small Size
3930	Cooling Kit up to 2,800 Btu/hr. (706 Kcal/hr.), Medium Size
3998	Cooling Kit up to 10,200 Btu/hr. (2,570 Kcal/hr.), Large Size

Vortex Tubes

Model #	Description
3202	Vortex Tube, 2 SCFM (57 SLPM), for max. refrigeration, 135 Btu/hr. (34 Kcal/hr.), Small Size
3204	Vortex Tube, 4 SCFM (113 SLPM), for max. refrigeration, 275 Btu/hr. (69 Kcal/hr.), Small Size
3208	Vortex Tube, 8 SCFM (227 SLPM), for max. refrigeration, 550 Btu/hr. (139 Kcal/hr.), Small Size
3210	Vortex Tube, 10 SCFM (283 SLPM), for max. refrigeration, 650 Btu/hr. (164 Kcal/hr.), Medium Size
3215	Vortex Tube, 15 SCFM (425 SLPM), for max. refrigeration, 1,000 Btu/hr. (252 Kcal/hr.), Medium Size
3225	Vortex Tube, 25 SCFM (708 SLPM), for max. refrigeration, 1,700 Btu/hr. (428 Kcal/hr.), Medium Size
3230	Vortex Tube, 30 SCFM (850 SLPM), for max. refrigeration, 2,000 Btu/hr. (504 Kcal/hr.), Medium Size
3240	Vortex Tube, 40 SCFM (1,133 SLPM), for max. refrigeration, 2,800 Btu/hr. (706 Kcal/hr.), Medium Size
3250	Vortex Tube, 50 SCFM (1,416 SLPM), for max. refrigeration, 3,400 Btu/hr. (857 Kcal/hr.), Large Size
3275	Vortex Tube, 75 SCFM (2,124 SLPM), for max. refrigeration, 5,100 Btu/hr. (1,285 Kcal/hr.), Large Size
3298	Vortex Tube, 100 SCFM (2,832 SLPM), for max. refrigeration, 6,800 Btu/hr. (1,714 Kcal/hr.), Large Size
3299	Vortex Tube, 150 SCFM (4,248 SLPM), for max. refrigeration, 10,200 Btu/hr. (2,570 Kcal/hr.), Large Size
3402	Vortex Tube, 2 SCFM (57 SLPM), for max. cold temperature, Small Size
3404	Vortex Tube, 4 SCFM (113 SLPM), for max. cold temperature, Small Size
3408	Vortex Tube, 8 SCFM (227 SLPM), for max. cold temperature, Small Size
3410	Vortex Tube, 10 SCFM (283 SLPM), for max. cold temperature, Medium Size
3415	Vortex Tube, 15 SCFM (425 SLPM), for max. cold temperature, Medium Size
3425	Vortex Tube, 25 SCFM (708 SLPM), for max. cold temperature, Medium Size
3430	Vortex Tube, 30 SCFM (850 SLPM), for max. cold temperature, Medium Size
3440	Vortex Tube, 40 SCFM (1,133 SLPM), for max. cold temperature, Medium Size
3450	Vortex Tube, 50 SCFM (1,416 SLPM), for max. cold temperature, Large Size
3475	Vortex Tube, 75 SCFM (2,124 SLPM), for max. cold temperature, Large Size
3498	Vortex Tube, 100 SCFM (2,832 SLPM), for max. cold temperature, Large Size
3499	Vortex Tube, 150 SCFM (4,248 SLPM), for max. cold temperature, Large Size

Vortex Tube Accessories and Components

Model #	Description
3905	Cold Muffler for 2 through 8 SCFM (57-227 SLPM) Vortex Tube, Small Size
3901	Cold Muffler for 10 through 40 SCFM (283-1,133 SLPM) Vortex Tube, Medium Size
3906	Cold Muffler for 50 through 150 SCFM (1,416-4,248 SLPM) Vortex Tube, Large Size
3903	Hot Muffler for 2 through 40 SCFM (57-1,133 SLPM) Vortex Tube, Small & Medium Size
3907	Hot Muffler for 50 through 150 SCFM (1,416-4,248 SLPM) Vortex Tube, Large Size
3909	Generator Kit for 2 through 8 SCFM (57-227 SLPM) Vortex Tube, Small Size
3902	Generator Kit for 10 through 40 SCFM (283-1,133 SLPM) Vortex Tube, Medium Size
3910	Generator Kit for 50 through 150 SCFM (1,416-4,248 SLPM) Vortex Tube, Large Size

Generator Kits ordered with a vortex tube include all generators for the specified tube. Permits setting the vortex tube for all capacities and styles.

Generator Only—Specify capacity (SCFM) and style ("R" for max. refrigeration, "C" for max. cold temperature).

Example:

15-R = 15 SCFM Generator for max. refrigeration
50-C = 50 SCFM Generator for max. cold temperature

Accessories

Model #	Description
9001	Automatic Drain Filter Separator, 3/8 NPT, 65 SCFM (1,841 SLPM)
9032	Automatic Drain Filter Separator, 1/2 NPT, 90 SCFM (2,549 SLPM)
9002	Automatic Drain Filter Separator, 3/4 NPT, 220 SCFM (6,230 SLPM)
9005	Oil Removal Filter, 3/8 NPT, 15-37 SCFM (425-1,048 SLPM)
9006	Oil Removal Filter, 3/4 NPT, 50-150 SCFM (1,416-4,248 SLPM)
9015	Valve and Thermostat Kit, 120V, 50/60Hz, 1/4 NPT, 40 SCFM (1,133 SLPM)

Other solenoid valves and thermostats available. Contact factory.

Note: Flow ratings shown (SCFM/SLPM) assume 100 PSIG (6.9 BAR) inlet pressure. At other pressures, flow is proportional to absolute inlet pressure.



Order Direct
We Ship From Stock

www.exair.com techhelp@exair.com

GO GREEN

Order EXAIR's EFC™ electronic flow control to minimize compressed air use. See page 7 for details.

SAVE MONEY

Adjustable Spot Cooler

Cold air to -30°F (-34°C) from your compressed air supply for spot cooling!



What Is The Adjustable Spot Cooler?

A low cost, reliable, maintenance free solution to a variety of industrial spot cooling problems. With the turn of a knob, you can select the temperature best suited to your application.

The Adjustable Spot Cooler provides a precise temperature setting from -30°F (-34°C) to room temperature.

The Adjustable Spot Cooler incorporates a vortex tube that converts an ordinary supply of compressed air into cold air.

- It can produce temperatures from -30° to +70°F (-34° to +21°C)
- Parts included for flow rates of 15, 25, and 30 SCFM (425, 708 and 850 SLPM). 25 SCFM (708 SLPM) generator is factory installed.
- It can produce refrigeration up to 2,000 Btu/hr. (504 Kcal/hr.)

A swivel magnetic base provides easy mounting and portability. Flexible tubing that holds its position directs the cold air. No moving parts or CFC's assures maintenance free operation.

Why The Adjustable Spot Cooler?

The Adjustable Spot Cooler is quiet (less than 75 dBA), easily set with a thermometer and holds the temperature setting. It's ideal for applications where mist or liquid cooling can not be used due to part contamination or cost. Tolerances, product finish and production rates can improve dramatically.

The Adjustable Spot Cooler is available with either a single point or dual point hose kit. The single point system (Model 3825) is recommended for cooling a small surface like solder joints, hot melts or drilled plastics. The dual point system (Model 3925) is recommended when heat is generated over a larger surface area.

Applications

- Adjusting thermostats
- Cooling solder
- Cooling machined plastics
- Setting hot melts
- Cooling welding horns
- Cooling molded plastics
- Electronic component cooling
- Cooling gas samples
- Cooling environmental chambers

Advantages

- No moving parts
- No electricity or chemicals
- Small, lightweight
- Low cost
- Maintenance free
- Instant cold air
- Quiet - less than 75 dBA
- Swivel magnetic base
- Interchangeable generators



PVC hose is cooled at the exit of an extruder so it can be coiled immediately.



The Adjustable Spot Cooler replaces flood coolant and eliminates hours of cleanup on a cast iron machining operation.



The Adjustable Spot Cooler maintains critical tolerances on machined plastic parts.

Adjustable Spot Cooler

How The Adjustable Spot Cooler Works

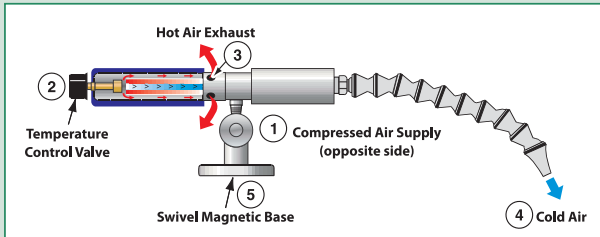

The Adjustable Spot Cooler incorporates a vortex tube to convert an ordinary supply of compressed air (1) into two low pressure streams, one hot and one cold. (For complete information on vortex tube operation, see page 160.) With the turn of a knob, the **temperature control valve** (2) allows some hot air to flow through a muffling sleeve and out the **hot air exhaust** (3). The opposite end provides a cold airstream (4) that is muffled and discharged through the flexible hose, which directs it to the point of use. The **swivel magnetic base** (5) provides easy mounting and portability.

Specifications

Pressure Supply		Air Consumption		Sound Level
PSIG	BAR	SCFM	SLPM	dBA
100	6.9	15	425	72
100	6.9	25*	708	73
100	6.9	30	850	74

* 25 SCFM (708 SLPM) generator is factory installed



The Model 3825 Adjustable Spot Cooler can produce temperatures from -30° to $+70^{\circ}$ F (-34° to $+21^{\circ}$ C).

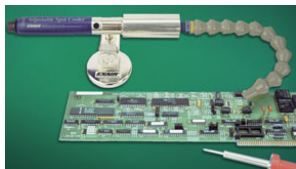

Electronic components stay cool during a soldering operation.

Dimensions

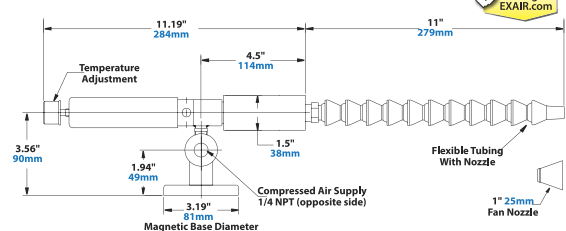

Adjusting the Spot Cooler

The Adjustable Spot Cooler System can produce a full range of airflow and temperatures as determined by the knob setting and a small internal part called a generator. The generators control the SCFM (SLPM) of air consumption and are easily interchangeable.

The Adjustable Spot Cooler has a 25 SCFM (708 SLPM) generator installed that produces up to 1,700 Btu/hr. (429 Kcal/hr.). If less cooling is desired, the 15 SCFM (425 SLPM) generator which delivers 1,000 Btu/hr. (252 Kcal/hr.) can be installed. If more cooling is needed, the 30 SCFM (850 SLPM) generator can be installed for up to 2,000 Btu/hr. (504 Kcal/hr.).

Controlling the Cold Air

The Adjustable Spot Cooler gives instant cold air when filtered compressed air is supplied to it. Cycling on and off is a good way to save air. For on and off control, use a Model 9012 Manual Shutoff Valve. To turn the Adjustable Spot Cooler on with the machine, the Model 9020 Solenoid Valve may be used and wired through the machine control switch. The EFC electronic flow control shown on page 7 can also be used.

Testing Heat Tape Thermostats

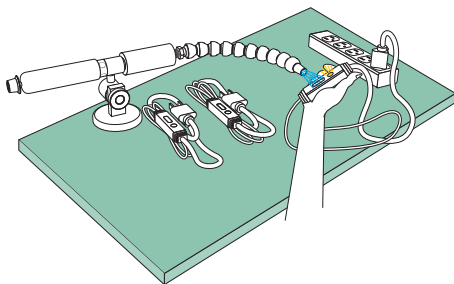

The Problem: A manufacturer of electrical heat tapes had a problem testing thermostats for accuracy. The heat tape is supposed to switch on when the outdoor temperature dips below 40°F to prevent pipes from freezing or ice from building up on a roof's edge. The liquid-tight thermostat of every tape had to be dipped into a bowl of ice water (thermometer checked at 36°F (2°C)) to make

sure the indicator light came on and the tape got warm. Summertime heat caused the water to heat up so quickly that more time was spent regulating the water temperature than testing thermostats.

The Solution: The water bath was replaced with a **Model 3825 Adjustable Spot Cooler**. Once set to their desired temperature of 36°F (2°C), it provided a stable temperature all day long without adjustment. Drying each heat tape was no longer required and testing was over in seconds.

Comment: The Adjustable Spot Cooler paid for itself in no time as a result of the increased productivity. In this case, **the company used the included 15 SCFM (425 SLPM) generator which minimized the compressed air use, costing only 23 cents per hour of continuous use!** When testing thermostats, cooling machined plastics, setting hot melts or controlling tolerances, the Adjustable Spot Cooler is the best choice.

Adjustable Spot Cooler Systems



Model 3825 Adjustable Spot Cooler System

includes the Adjustable Spot Cooler, single point hose kit with cone and fan nozzle, swivel magnetic base, filter separator, 15 and 30 SCFM (425 and 850 SLPM) generators. (25 SCFM/708 SLPM generator installed.)



Model 3925 Adjustable Spot Cooler System

includes the Adjustable Spot Cooler, dual point hose kit with cone and fan nozzles, swivel magnetic base, filter separator, 15 and 30 SCFM (425 and 850 SLPM) generators. (25 SCFM/708 SLPM generator installed.)

(Adjustable Spot Cooler with dual point hose kit is recommended when heat is generated over a larger surface area.)

Accessories and Components

Model #	Description
5901	Single Point Hose Kit (Included with 3825)
5902	Dual Point Hose Kit (Included with 3925)
9004	Auto Drain Filter Separator, 1/4 NPT, 43 SCFM (1,359 SLPM) (Included with 3825 and 3925)
9005	Oil Removal Filter, 3/8 NPT, 15-37 SCFM (425-1,048 SLPM)
9012	Manual Shutoff Valve, 1/4 NPT
9020	Solenoid Valve, 120V, 50/60Hz, 1/4 NPT, 40 SCFM (1,133 SLPM)

GO GREEN



Order EXAIR's EFC™ electronic flow control to minimize compressed air use. See page 7 for details.



Mini Cooler™

Cool small parts and tools with clean, cold air!

Prevent burning, melting or breakage!

What Is The Mini Cooler?

A proven way to reduce downtime and increase productivity on a variety of operations involving small parts where heat is a problem. EXAIR's Mini Cooler produces a stream of 20°F (-7°C) cold air to prevent heat build-up. The Mini Cooler is particularly effective on high speed operations to prevent burning, melting and heat related breakage. Operation is quiet (76 dBA) and there are no moving parts to wear out.



Mini Cooler Specifications

Air Consumption		Temperature Out		Sound @ 3' (914mm)	
SCFM	SLPM	°F	°C	dBA	INLET
8	227	20	-7	76	1/4 NPT

Supply air at 100 PSIG (6.9 BAR) & 70°F (21°C)

How The Mini Cooler Works

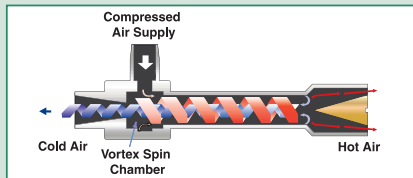

The Mini Cooler incorporates a vortex tube to convert a small amount of compressed air into two low pressure streams, one moving within the other in opposite directions (see page 160). The two airstreams exchange heat, producing cold air from one end of the tube and hot air from the other. A flexible hose directs the cold airstream at the surface to be cooled.

Dimensions

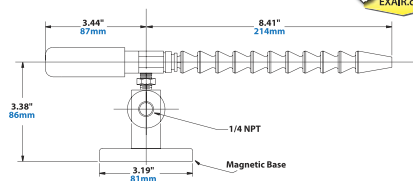

Applications

- Small tool cooling
- Needle cooling
- Blade cooling
- Lens grinding

Advantages

- Low cost
- Increases production rates
- Improves tolerances
- Quiet, compact

Mini Cooler Systems



Model 3808
Mini Cooler System
(one cold outlet)

Includes Mini Cooler, Single Point Hose Kit, Swivel Magnetic Base and Manual Drain Filter Separator with Mounting Bracket.



Model 3308
Mini Cooler System
(two cold outlets)

includes Mini Cooler, Dual Point Hose Kit, Swivel Magnetic Base and Manual Drain Filter Separator with Mounting Bracket.

Mini Cooler

Model #	Description
3808	Mini Cooler System (one cold outlet) includes the Mini Cooler, swivel magnetic base, mini single point hose kit and manual drain filter with mounting bracket
3308	Mini Cooler System (two cold outlets) includes the Mini Cooler, swivel magnetic base, mini dual point hose kit and manual drain filter with mounting bracket

Accessories

Model #	Description
5904	Mini Cooler Single Point Hose Kit (Included with 3808)
5905	Mini Cooler Dual Point Hose Kit (Included with 3308)
9003	Manual Drain Filter Separator, 1/4 NPT (Included with 3808 and 3308)
9012	Manual Shutoff Valve, 1/4 NPT
9027	Oil Removal Filter, 1/4 NPT, 24 SCFM (680 SLPM)