

EXAIR®

MANUFACTURING INTELLIGENT COMPRESSED AIR® PRODUCTS SINCE 1983



COAT



CONSERVE



COOL



CONVEY



CLEAN



NEW

- Ion Air Cannon... pg. 108
- Ion Air Gun..... pg. 110

30
CATALOG

TECHHELP
1-800-903-9247
DIRECT

YOU REQUESTED THIS CATALOG AND PRICE LIST.
PLEASE SEE MAILING LABEL ON BACK COVER.

Stay up to date by visiting our website and take advantage of the information and services we didn't have room to display in this catalog.

EXAIR.com®

The digital home of Intelligent Compressed Air® products for industry



Where you can

- **Chat live** with our problem solving, technical expert Application Engineers
- **Watch product videos** to learn more about the features and benefits of our engineered products
- Quickly **order online** with a purchase order or credit card (US & Canada)
- **Access product presentation slides** you can use to educate others
- **Find International Distributors** all across the world



Access our Knowledge Base to

- **Download 3D models** and CAD drawings in multiple formats to place into your drawings
- **Calculate air savings and ROI** to see how quickly EXAIR products will pay off
- Search our **Case Study Library & Applications** database and become familiar with how our products solve problems
- **Use our product FAQ's** for quick access to our most common questions
- Learn about our free Efficiency Lab service and use it to **determine air and money savings** you can achieve when installing EXAIR engineered solutions
- Collect compressed air data and pipe sizing recommendations
- **Find Flow, Force and Heat conversions**



Visit our PDF library and download

- Electronic files of **the entire catalog** or individual sections
- **Installation and Maintenance Guides** on every EXAIR product
- Our current **price list** to have all product prices in one convenient location
- EXAIR's **Air Nozzle Blowoff Guide** to see the details on our enormous selection of sizes, materials and performance options



Follow our blog for 5 new entries a week and learn

- Details and installations of widely varied applications
- The methodology and results of critical mathematical formulas which help determine money savings, air savings, performance benefits and more
- New product releases before they reach our catalog or website
- More about EXAIR, our team and community involvement
- **Go to** blog.exair.com

Make social connections

- Watch **over 80 videos** on EXAIR's YouTube Channel and see product features and benefits, applications, Tips & Tricks, How-to, our team members, or be entertained by Professor Penurious!
- **Follow our Company on Twitter @EXAIR** or our Application Engineers and learn more about promotions, updates on manufacturing, engineering and international industry perspective.



@EXAIR_BF



@EXAIR_JB



@EXAIR_JN



@EXAIR_KE



@EXAIR_LE



@EXAIR_NR



@EXAIR_RB

- **Connect with us on Facebook** at facebook.com/exair or follow us on Google+



Not on a PC? Our website is mobile friendly

Terms and Conditions 4
 Efficiency Lab 5



EXAIR Optimization

Minimize compressed air use and detect wasteful leaks

6 Steps to Optimization 6
 Electronic Flow Control 7
 Digital Sound Level Meter 10
 Ultrasonic Leak Detector 11
 Digital Flowmeter 13



Air Knives

Blowoff, clean, dry and cool with less noise and air consumption

Super Air Knife 15
 Compare Blowoffs 18
 Explanation of Materials 21
 Universal Air Knife Mounting System 24
NEW Plumbing Kits 24
 Long Super Air Knife 26
 Standard Air Knife 28
 Full-Flow Air Knife 31



Air Wipes

Blowoff, dry, clean and cool pipe, cable, extruded shapes and hose

Super Air Wipes 33
 Standard Air Wipes 37



Air Amplifiers

Vent, exhaust, cool, dry and clean - with no moving parts

Super Air Amplifiers 41
 Adjustable Air Amplifiers 45



Air Nozzles and Jets

Reduce noise levels and air costs on blowoff operations

Air Nozzles 47
 Air Nozzle Comparison Chart 49
 Super Air Nozzles 50
 Flat Super Air Nozzles 52
 Back Blow Air Nozzles 54
 Safety Air Nozzles 55
NEW Air Jets 56
 High Force Air Nozzles 58
 High Force Air Nozzle Comparison Chart 58
 High Force Flat Super Air Nozzles 58
 High Force Super Air Nozzles 58
 Super Air Nozzle Clusters 62
 Stay Set Hoses 63
 Swivel Fittings 63
 Blowoff Systems 64



Atomizing Nozzles

All stainless steel construction for durability and corrosion resistance

1/4 NPT Atomizing Nozzles 66
 Internal Mix Narrow Angle Round Atomizing Nozzles 66
 Internal Mix Wide Angle Round Atomizing Nozzles 67
 Internal Mix Flat Fan Atomizing Nozzles 68
 Internal Mix Deflected Flat Fan Atomizing Nozzles 69
 Internal Mix 360° Hollow Circular Atomizing Nozzles 69
 External Mix Round Atomizing Nozzles 70

Atomizing Nozzles continued

External Mix Narrow Angle Flat Fan Atomizing Nozzles 71
 External Mix Wide Angle Flat Fan Atomizing Nozzles 72
 Siphon Fed Round Atomizing Nozzles 73
 Siphon Fed Flat Fan Atomizing Nozzles 74
 1/2 NPT Atomizing Nozzles 75
 Internal Mix Narrow Angle Round Atomizing Nozzles 75
 Internal Mix Wide Angle Round Atomizing Nozzles 76
 Internal Mix Flat Fan Atomizing Nozzles 77
 Internal Mix 360° Hollow Circular Atomizing Nozzles 78
 External Mix Narrow Angle Flat Fan Atomizing Nozzles 79
 Siphon Fed Round Atomizing Nozzles 80



No Drip Atomizing Nozzles

Eliminate drips to conserve valuable liquids and improve product finishes.

1/4 NPT No Drip Atomizing Nozzles 82
 No Drip Internal Mix Narrow Angle Round Atomizing Nozzles 82
 No Drip Internal Mix Wide Angle Round Atomizing Nozzles 82
 No Drip Internal Mix Flat Fan Atomizing Nozzles 82
 No Drip Internal Mix Deflected Flat Fan Atomizing Nozzles 82
 No Drip Internal Mix 360° Hollow Circular Atomizing Nozzles 82
 No Drip External Mix Round Atomizing Nozzles 83
 No Drip External Mix Narrow Angle Flat Fan Atomizing Nozzle 83
 No Drip External Mix Wide Angle Flat Fan Atomizing Nozzle 83
 No Drip Siphon Fed Round Atomizing Nozzles 83
 No Drip Siphon Fed Flat Fan Atomizing Nozzles 83
 1/2 NPT No Drip Atomizing Nozzles 82
 No Drip Internal Mix Narrow Angle Round Atomizing Nozzles 82
 No Drip Internal Mix Wide Angle Round Atomizing Nozzles 82
 No Drip Internal Mix Flat Fan Atomizing Nozzles 82
 No Drip Internal Mix 360° Hollow Circular Atomizing Nozzles 82
 No Drip External Mix Narrow Angle Flat Fan 83
 No Drip Siphon Fed Round Atomizing Nozzles 83
 Droplet Size/Spray Angle Information 84

85



Safety Air Guns

Safety air guns use engineered air nozzles for high performance

Chip Shields	86
Precision Safety Air Guns	87
Soft Grip Safety Air Guns	87
Heavy Duty Safety Air Guns	90
Back Blow Safety Air Guns	91
Super Blast Safety Air Guns	92

94



Static Eliminators

Eliminate static electricity, dust and shock hazard

Super Ion Air Knife	96
Static Meter	98
Standard Ion Air Knife	102
Ionizing Bars	104
Super Ion Air Wipes	106
Ion Air Cannon	108
Ion Air Gun	110
Ion Air Jet/Stay Set Ion Air Jet	112
Ionizing Point	114
Power Supplies	115

116

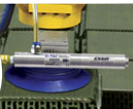

E-Vac® Vacuum Generators

Vacuums for lifting, clamping, mounting and placement

How to Build an E-Vac System	117
In-Line	118
Adjustable	121
Vacuum Cups	123

127



Air Operated Vacuums

Convey parts, materials and waste - with no moving parts

Line Vac	127
Threaded Line Vac	133
Heavy Duty Line Vac	136
Light Duty Line Vac	138

140



Industrial Housekeeping

Reliable vacuums for chip removal, liquid transfer and cleaning

Reversible Drum Vac	140
High Lift Reversible Drum Vac	142
Chip Trapper	144
High Lift Chip Trapper	146
Chip Vac	148
Heavy Duty Dry Vac	150
Heavy Duty HEPA Vac	152
Vac-u-Gun	154
Deep Hole Vac-u-Gun	156
Air Stik Window	158

159



Vortex Tubes & Spot Cooling

Cold air for industrial spot cooling problems

Vortex Tubes	159
Adjustable Spot Cooler	167
Mini Cooler	170

171



Cold Gun Aircoolant Systems

Cool machining operations with clean, cold air

175



Cabinet Cooler® Systems

Cool and purge NEMA 12, 4 and 4X electrical control panels

How it Works	176
Selecting the Right Model	176
Special Duty Cabinet Coolers	177
Calculating Heat Load	179
Cabinet Cooler Sizing Guide	180
NEMA 12 Models	182
NEMA 4 Models	183
NEMA 4X Models	184
Cabinet Cooler System Accessories	185

186



Accessories

Mufflers, filters, regulators, valves, swivel fittings and more

Filters	186
Regulators	187
Silencing Mufflers	188
Valves, Swivels, Thermostats	190
Magnetic Bases, Stay Sets, Hoses	191
Air Hoses	191
Fittings	192
Receiver Tank	192

ORDER BY
3PM
SHIPS SAME DAY

Catalog item orders received before 3 pm EDT/ EST are generally shipped from Cincinnati, Ohio on the same day. You can expect delivery within 1-4 days depending on your location.

Terms and Conditions (U.S. and Canada Only)

Terms: Net 30 days upon credit approval, Visa, MasterCard, Discover and American Express.



Cards

ICC (International Chamber of Commerce) INCOTERM 2010: EX WORKS (EXAIR Corporation, 11510 Goldcoast Dr., Cincinnati, Ohio 45249, USA)

Delivery: All cataloged products are shipped from stock, via U.P.S. within 24 hours after receipt of order. Priority shipment is available upon request.

Ordering: Call 1-800-903-9247 or +1-513-671-3322 Worldwide
8:00 a.m. to 5:00 p.m. ET (Mon. - Fri.)

Fax toll free 1-866-329-3924 or
+1-513-671-3363 Worldwide

E-mail: orders@exair.com
www.exair.com (secure web site)

Remit to address (payments only):

EXAIR Corporation
Location 00766
Cincinnati, Ohio 45264-0766

Tax: Sales and use tax, where applicable, are not included.

OSHA and CE Compliance: EXAIR compressed air products comply with OSHA's Safety Requirements, the EU General Product Safety Directive (2001/95/EC) and meet the noise limitation requirements of the EU Machinery Directive (2006/42/EC). EXAIR's Electronic Flow Control and Electronic Temperature Control meet the low voltage standards of the EU Low Voltage Directive (2006/95/EC). Some EXAIR products display the CE mark where there are applicable directives. All sound level measurements are taken at 3 feet away.

RoHS: Electrical portions of EXAIR's static eliminators, EFC, ETC, solenoid valves, and thermostats comply with the RoHS (Restriction of Hazardous Substances) Directive 2002/95/EC, including the amendment outlined in the European Commission decision L 214/65.

Reach: Per Regulation (EC) No 1907/2006 Title I, Article 3, paragraph 3, the European Union has recently enacted legislation to register chemicals and substances imported into the EU to ensure a high level of protection of human health and the environment.

Per Title II, Article 7, paragraph 1, articles (products) must be registered when a substance is intended to be released under normal or reasonably foreseeable conditions of use and it is present in those articles in quantities totaling over 1 metric ton per producer or importer per year. Registration of EXAIR products is not required since they do not contain substances that are intentionally released.

Conflict Mineral Free: Look for this symbol to designate conflict mineral free products throughout our catalog. EXAIR supports Section 1502 of the Dodd-Frank Wall Street Reform and Consumer Protection Act and we are committed to compliance with the conflict minerals rule in order to curb the illicit trade of tin, tantalum, tungsten and gold in the DRC region. EXAIR is using the CMRT 3.02 template to document our supply chain and commitment to conflict free products.

Copyright Restrictions: The content of the EXAIR Catalog, including all photos, graphics, drawings and arrangements are proprietary to EXAIR Corporation and are protected by the United States and international copyright and trademark laws. You are authorized to use the contents of the EXAIR Catalog for personal use or as it relates to your role as a current or prospective customer of EXAIR. The contents of this catalog may not be copied or modified for any type of publication or distribution without the prior written consent of EXAIR Corporation. The content of the EXAIR Catalog is the intellectual property solely of the EXAIR Corporation with no rights transferred to other parties. No part of this catalog may be reproduced for any commercial purposes without the express authorization in writing by the EXAIR Corporation.

Trademarks: "EXAIR.com", "EXAIR", "Cabinet Cooler", "E-Vac", "Intelligent Compressed Air", and "Compressed Air Intelligence" are registered trademarks of the EXAIR Corporation. The EXAIR logo, product names, designs and descriptive phrases are trademarked by EXAIR Corporation. These trademarks may not be used without prior written permission of the EXAIR Corporation.

EFC, Digital Flowmeter, Digital Sound Level Meter, High Power Cold Gun, Super Air Knife, Standard Air Knife, Full-Flow Air Knife, Air Cannon, Super Air Amplifier, Adjustable Air Amplifier, Super Air Nozzle, Micro Air Nozzle, High Power Safety Air Nozzle, Stay Set Hose, Super Blast Safety Air Gun, Super Air Wipe, Standard Air Wipe, Super Ion Air Knife, Standard Ion Air Knife, Super Ion Air Wipe, Ion Air Cannon, Ion Air Gun, Ion Air Jet, Ionizing Point, Stay Set Ion Air Jet, Line Vac, Chip Vac, Heavy Duty Dry Vac, Heavy Duty HEPA Vac, Reversible Drum Vac, High Lift Reversible Drum Vac, Chip Trapper, High Lift Chip Trapper, Vac-u-Gun, Deep Hole Vac-u-Gun, Air Disk, Air Stick, Mini Cooler, Cold Gun Aircontrol System, and ETC are trademarks of EXAIR Corporation.



Intelligent Compressed Air® products are identified throughout this catalog that can help your plant save tens of thousands of dollars over the course of a single year. *The Best Practices for Compressed Air Systems* manual published by the Compressed Air Challenge® recommends products like the Super Air Knife®, Super Air Amplifier®, and the family of Super Air Nozzles® for energy conservation. Many of the products shown offer unique ways to solve common industrial problems using compressed air. Compressed Air Challenge is a registered trademark of Compressed Air Challenge, Inc.

EXAIR products are subject to ongoing development. Specifications are subject to change without notice. Some products in this catalog are covered by U.S. Patent #5402938, #8153001, #8268179, and #9156045, and others may be U.S. Patent Pending. Copyright © 2016 EXAIR Corporation. All Rights Reserved.

Technical Assistance: Please call our Application Engineering Department, 1-800-90-EXAIR (1-800-903-9247), or e-mail at techelp@exair.com.

Warranty: 5 Year "Built To Last" Warranty against defects in workmanship and materials on all compressed air products*. Defective products must be returned freight prepaid for repair or replacement at our option. This warranty applies under conditions of normal use, but does not apply to defects that result from intentional damage, negligence, unreasonable use, wear or exposure.

Built to Last 5 Year WARRANTY

*5 Year Warranty applies to compressed air products only.

A 1 Year Warranty applies to all accessories and electrically powered products.

EXAIR's Unconditional Guarantee:

Extends to all U.S. and Canadian customers and includes invoiced U.P.S. Ground Service shipping charges. Products returned after the 30 day guarantee period are subject to a 15% restocking charge. Products must be returned freight prepaid.

EXAIR Corporation

11510 Goldcoast Dr.
Cincinnati, Ohio 45249-1621
Phone Number: (513) 671-3322
Fax Number: (513) 671-3363
E-mail: techelp@exair.com
Web Site: www.exair.com



EXAIR®

EFFICIENCYLAB



EXAIR's Intelligent Compressed Air® products vs Your current installation

How does the Efficiency Lab work?

Our Efficiency Lab service begins with receiving a sample of the product(s) you currently use for your application. One of our qualified Application Engineers will use calibrated testing equipment to compare the performance of your existing product(s) to an EXAIR engineered solution. These tests will determine air consumption, noise levels and force. The test results will then be published in a comprehensive report, which includes a cost savings analysis, and be provided to you. For most applications, EXAIR products can help you improve application efficiency AND typically pay for themselves in a matter of weeks.

How can I get a product tested for free?

To participate in our FREE Efficiency Lab please contact one of our Application Engineers and get the details about sending us your product(s).

You may reach an application Engineer by phone at (800) 903-9247 or (513) 671-3322. You can send an email to lab@exair.com or visit our website and take advantage of our live help at www.exair.com.

EXAIR's FREE Efficiency Lab service determines how much air and dollar savings you will achieve by installing one of our Intelligent Compressed Air products.

Unable to send your product to EXAIR's Efficiency Lab?

If it is not possible to send us your product, we have a one page Product Efficiency Survey on our website (www.exair.com/labdoc.htm) which will provide us the details about a current inefficient compressed air application. Fill in the information and click submit. You will hear from one of our Application Engineers within 3 business days.

Okay, so what is the fine print?

This offer is available to all customers in the U.S. and Canada only. Some restrictions may apply.

What about confidentiality?

Yes, EXAIR will keep the results of our Efficiency Lab test and report confidential unless given permission to share that information with others.

Products must be shipped to EXAIR freight prepaid. EXAIR will pay the return shipping via UPS ground.

Static Eliminators

Eliminate static and dust!

Neutralize and clean at distances up to 20 feet!



Static Eliminators

What Is Static?

Material such as paper, plastic or textiles normally contain an equal number of positive and negative charges – that is, they are electrically balanced. Friction can disturb this balance, causing the material to become electrically charged.

The electrical charge (static) will exert a force on nearby charged objects or a grounded conductor. Among the problems caused by this force are:

- Dust clinging to product
- Product clinging to itself, rollers, machine beds or frames
- Materials tearing, jamming or curling
- Sheet feeding problems
- Hazardous sparks or shocks



Charged conductors (like metals) discharge completely when grounded. Insulators (like plastics) don't conduct electricity and can't discharge when grounded. Grounded brushes or tinsel often have little effect on these surfaces.

When aiming EXAIR's Model 7905 Static Meter at a single plastic surface, it is common to measure many voltages across the same surface. The higher the voltage measured, the stronger the static charge or force at that point. It is also possible for some voltages to have opposite polarities (positive or negative) which determines if two insulators will attract or repel one another.

EXAIR's static eliminators (called ionizers) can eliminate the charge. These shockless ionizers are electrically powered and produce a bulk of positive and negative ions. The charged surface attracts the appropriate number of positive or negative ions from the ionizer to become neutral (discharged).

Selecting The Right Static Eliminator

EXAIR offers systems for total static control. When static is a problem on moving webs, sheet stock, three dimensional parts, extrusions or packaging, EXAIR has a solution.

Static Eliminators With Air

Combining our engineered airflow products with ionizers gives us the ability to eliminate the charge quickly and at great distances. Laminar flow airstreams make it possible to blow away any contaminants and the charge that attracts them. They are ideal for:

- Hard to reach places or obstructed surfaces
- Product moving at high speeds
- Surfaces with an extremely high charge

Compressed air consumption and noise are minimized while providing force that can be adjusted from a "blast" to a "breeze". Tests show these ionizers positioned two feet (610mm) away from a charged surface to be as effective as an Ionizing Bar without air delivery positioned one-half inch (13mm) from the surface.

The **Super Ion Air Knife** provides the best performance of all ionizers. It uses our Super Air Knife (40:1 air amplification) to deliver a uniform sheet of ionized air effective up to 20 feet (6.1m) away.

The **Standard Ion Air Knife** uses our Standard Air Knife (30:1 air amplification) to deliver a sheet of ionized air to the surface. Air consumption and noise are somewhat higher than the Super Ion Air Knife.

The **Super Ion Air Wipe** clamps around the part and creates a ring of ionized airflow. It neutralizes and cleans continuous moving surfaces.

The **Ion Air Cannon** uses our Super Air Amplifier (22:1 air amplification) to provide a focused, conical airstream that is capable of removing the charge up to 15 feet (4.6m) away.

The **Ion Air Gun** uses our High Velocity Air Jet (5:1 air amplification) to provide a narrow beam of ionized airflow. This hand-held static eliminator is rugged for industrial use and has incredibly fast static decay rates.

The **Ion Air Jet** uses our High Velocity Air Jet (5:1 air amplification), and is an effective spot cleaner. Available for permanent mount or with flexible Stay Set Hose, this ionizer is the ideal way to focus an ionized airflow at confined areas.

Static Eliminators Without Air

In some situations, even the smallest amount of airflow can disturb the product. This is especially true for lightweight materials. EXAIR manufactures two styles of ionizers for these critical applications.

Ionizing Bars are ideal for relatively flat materials, where the bar can be mounted close to the product surface.

The **Ionizing Point** is effective for spot neutralization. The compact size makes it ideal for winding or slitting operations. It can also be mounted through a duct to neutralize static charges due to moving air or materials.

Special Static Eliminators

EXAIR manufactures static eliminators suited to specific application requirements. This special ionizer (*shown bottom right*) was developed for the automotive industry. This air amplifier and ionizer combination is used to dry water based paints on car bodies while eliminating the possibility of a static charge that might attract dust or other contaminants.



A small Model 111113 3" (76mm) Super Ion Air Knife System eliminates contaminants from syringes prior to packaging.



A Model 7006 6" (152mm) Ionizing Bar eliminates the static charge causing packing peanuts to cling.



This special ionizer dries water based paint on car bodies and eliminates any static problems.

If you have special requirements, please contact an Application Engineer to discuss the application.

Super Ion Air Knife™

Powerful static eliminator prevents jamming, tearing, shocks and dust up to 20' away!

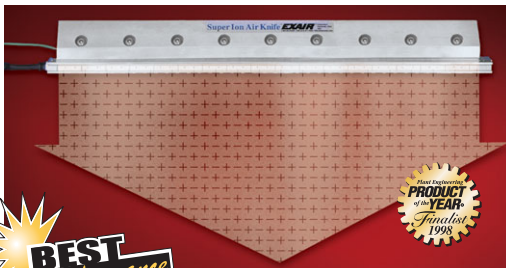

Uses The Super Air Knife

- ✓ **Low Air Consumption!**
- ✓ **Surprisingly Quiet!**
- ✓ **Uniform Airflow!**
- ✓ **End and Bottom Air Inlets!**

What Is The Super Ion Air Knife?

EXAIR's Super Ion Air Knife removes static electricity from plastics, webs, sheet stock and other product surfaces where tearing, jamming or hazardous shocks are a problem. The laminar sheet of air sweeps surfaces clean of static, particulate, dust and dirt. Production speeds, product quality, and surface cleanliness can improve dramatically.

Why The Super Ion Air Knife?

The Super Ion Air Knife floods an area or surface with static eliminating ions - up to 20 feet (6.1m) away. A uniform airflow across its length will not cause misalignments to critical surfaces such as webs. Force can be adjusted from a "blast" to a "breeze". The Super Ion Air Knife is electrically powered, is shockless and has no moving parts. **It also requires only 3.7 SCFM of compressed air per foot of length at 5 PSIG (105 SLPM per 300mm of length at 0.3 BAR).** Sound level is surprisingly quiet at 50 dBA for most applications.



The Super Ion Air Knife eliminates the static charge on labels being applied to PET soft drink bottles.

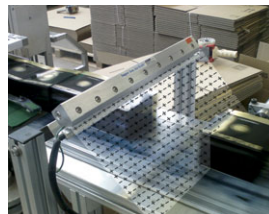

The Model 111118 18" (457mm) Super Ion Air Knife System eliminates dust from body care products prior to sealing the boxes in cellophane.



Bumpers, car bodies and fascia are cleaned of dust and fibers prior to painting.

Applications

- Web cleaning
- Molding machinery
- Sheeters and trimmers
- Cleaning parts
- Pre-paint dust removal
- Shrink wrappers
- Package cleaning
- Bag opening/fill operations
- Printing equipment

Advantages

- Low air consumption
- Uniform airflow across entire length
- Quiet
- Effective up to 20 feet (6.1m)
- Shockless, non-radioactive
- Compact, rugged, easy to install
- Unlimited system lengths of uninterrupted airflow
- Low maintenance
- Variable force and flow

How The Super Ion Air Knife Works

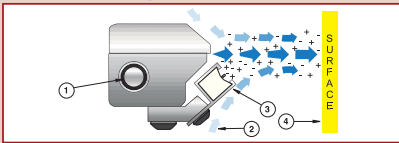

Compressed air flows through an inlet (1) into the plenum chamber of the Super Ion Air Knife. The flow is directed to a precise, slotted orifice. As the primary airflow exits, it creates a uniform sheet of air across the entire length that immediately pulls in surrounding room air (2). An electrically powered ionizing bar (3) fills the curtain of air with positive and negative charges. The airstream delivers these static eliminating ions to the product surface (4) where it is instantly neutralized and cleaned of dust and other particulates.

Super Ion Air Knife Performance

Pressure Supply		Air Consumption*		Sound Level	Dissipates
PSIG	BAR	SCFM	SLPM	dBA	5kV**
5	0.3	3.7	105	39	0.60
10	0.7	5.5	156	51	0.50
20	1.4	13.2	372	57	0.25
40	2.8	20.4	576	61	0.20
60	4.1	27.6	780	65	0.18
80	5.5	34.8	984	69	0.18
100	6.9	42.0	1,188	72	0.18

* per foot (305mm) of length

** 6" (152mm) from target

For airflow pattern, see Super Air Knife page 19.

Enhanced Performance and Reliability

Ionizing bars are less effective without an air delivery system. When used by itself, an ion bar must be mounted within two inches of the charged surface to fully neutralize it. This close mounting is impossible when the static is generated in confined areas of a machine. Ion coverage is minimal on oddly configured parts or when high production speeds are involved.

The right type of air delivery is critical. Blowers produce an uneven, turbulent airstream that can cause the positive and negative ions to recombine before hitting the charged material. They are large, suffer mechanical wear and provide limited airflow control. (For more information on blowers, see page 17.) The compact Super Ion Air Knife uses a small amount of compressed air to produce a balanced, laminar sheet of air to carry the ions to the charged surface, even when it is far away. Flow and force are easily controlled and there are no moving parts to wear out.

Added Features

- Compressed air inlets are provided on each end and the bottom of the Super Ion Air Knife.
- Shims can be installed easily if additional hard-hitting force is required.
- Primary air does not impact any surface of the Super Ion Air Knife which keeps the sound level low.
- Insertion molded emitter points eliminate potential dirt accumulation that could degrade performance or eventually short the ionizing bar.
- Emitter points are sharp, durable stainless steel.
- The power cable is shielded and has integral grounding. The threaded bayonet connector is fully assembled and ready to use.
- Super Ion Air Knife Kits, which include all components necessary for operation, are available.

Super Ion Air Knife Dimensions

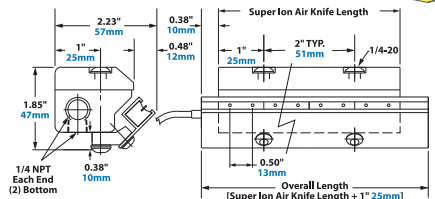

Static Eliminators

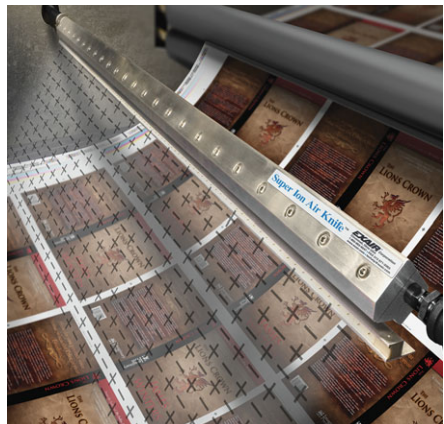

The Model 111048 48" (1219mm) Super Ion Air Knife neutralizes the static electricity and cleans the surface of the paper.

Super Ion Air Knife

Super Ion Air Knife Specifications

The Super Ion Air Knife is available in standard lengths of 3", 6", 9", 12", 18", 24", 30", 36", 42", 48", 54", 60", 72", 84", 96" and 108" (76, 152, 229, 305, 457, 610, 762, 914, 1067, 1219, 1372, 1524, 1829, 2134, 2438 and 2743mm).

Special lengths and unlimited system lengths are available (please contact our factory).

A 5' (1.52m) shielded power cable with ground and assembled bayonet connector are included.

EXAIR Model 7901, 7907, 7940 or 7941

Power Supply (5kV) is required for bar operation.

Power supplies are equipped with a 6' (1.83m) power cord, lighted power switch and (2) or (4) high voltage outlets. See page 115 for details.

Certifications: Ionizing Bars are UL Component Recognized to U.S. and Canadian safety standards. Power supplies are UL Listed to U.S. and Canadian safety standards, and are CE and RoHS compliant.

Compressed Air: 1/4 NPT inlets are provided on each end and the bottom.

Electrical: For use with 5 kVrms, 5 milliamperes (max.) power supply.

Electrical Hazard: Ionizing bars are shockless (less than 40 microamperes short circuited).

Do not use near flammable materials or gases.

Materials of Construction:

Metal Parts: Aluminum

Plastic Parts: UL rated 94 HB

Emitters: Stainless Steel

Maximum Ambient Temperature: 165°F (74°C)

Shims: Thicker shims can be installed easily if additional hard-hitting velocity is required. For more information, see "shim sets" on page 19.



Model 9060 Universal Air Knife Mounting System provides secure, precise positioning for the Super Ion Air Knife.

See page 24 for details.

Static Meter

Static Meter

Locate the source of the static problem!



Digital Static Meter Locates The Source!

The Model 7905 Digital Static Meter allows easy one-hand static measurements. In most cases, the highest voltage reading will indicate the source of the static problem. Sensitive and responsive, it indicates the surface voltage and polarity on objects up to ± 20 kV when measured one inch (25mm) away.

The Digital Static Meter features a push button "hold" for readings, a low battery indicator and an automatic "power off". A "zero" button to zero the instrument ensures an accuracy of $\pm 5\%$ of the reading when it is one inch (25mm) from the charged surface.



The Model 7905 Digital Static Meter comes complete with a hard-shell plastic case and a 9 volt battery. Certification of the accuracy and calibration traceable to NIST (National Institute of Standards and Technology) is also included. Calibration is available.

Dust Removal From Car Bodies

The Problem: Car bodies are primer coated, then sanded before entering the paint booth. Priming dust, attracted to the car body by a static charge, creates imperfections that are captured and magnified in the painting process.

The Solution: An "archway" of **Model 111024 24" (610mm) Super Ion Air Knives** was installed **upstream of the paint booth**. As the car bodies pass through, a **high velocity sheet of ionized air neutralizes the static charge to release the dust and blow it toward a collection system.**

Comment: Non-turbulent airflow was the reason this cleaning system worked so well. The compact Super Ion Air Knife has the ability to move the bulk of the static eliminating ions to the car surface. It can be adjusted from a gentle breeze of air to a pounding blast, with instant "on/off" capability. Uniform airflow across the entire length assures that all car body surfaces are neutralized and dust free. Best of all, the Super Ion Air Knife is easy on the compressed air system and workers' ears. They use much less compressed air than standard blowoffs and are around 69 dBA in most applications.

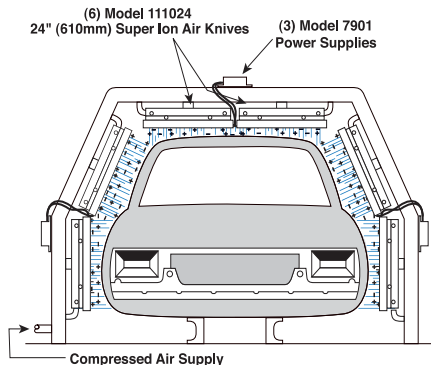

EXAIR's EFC (shown on page 7) is an electronic flow control for compressed air. It can sense when there is no car present and will automatically turn off the compressed air until the next car is moved into position. It is a perfect addition to this type of application.

Static Eliminators

A Manufacturer Of Perfumes And Fragrances Eliminates Dust From Their Packages



The Problem: A manufacturer of perfumes and fragrances had a problem with the packaging of their fine perfumes. The conveyor belt used to transport the boxes to the cellophane sealer rubbed against the box surface. This induced a sizable static electricity charge that made it a "dust magnet". The cardboard dust and particulates in their

facility would land on the perfume boxes that were sent through the cellophane sealer. The trapped dust gave a poor appearance to the finished package. The company refused to let the boxes with the poor appearance leave their facility. Attempts to clean them using ordinary air guns produced poor results.

The Solution: The company installed a **Model 111018 18" (457mm) Super Ion Air Knife** prior to the box entering the sealer. The charged surface was completely neutralized with the ionized airflow and the dust and particulates were blown away. The cellophane covered boxes were perfectly clean.

Comment: EXAIR's Super Ion Air Knife is used for applications just like these where appearance is vital to the sale of the product. The Super Ion Air Knife is commonly used for pre-package cleaning, bag opening and filling operations, cleaning automobile bodies prior to painting, web cleaning, as well as eliminating jams, tears and those painful static electricity shocks.

Cleaning Porcelain Dishes Prior To Glazing



The Problem: A manufacturer of fine porcelain dinnerware products had a problem with dust ruining the finish on their dishes. Dust particles were adhering to the surface of the dishes which created imperfections that were greatly magnified once the glaze was applied. Prior to glazing,

they made attempts to blow the dust particles away using ordinary air nozzles which had little effect, if any. There were abundant rejects.

The Solution: They installed (3) **Model 111018 18" (457mm) Super Ion Air Knives** to surround each dish, neutralize the static charge and remove the dust particles. Any airborne particulate was immediately vacuumed away by their dust collection system. The dishes were completely smooth to the touch with no imperfections.

Comment: A similar problem used to plague automotive manufacturers. The static charge generated by the tack off operation would cause the car body to attract stray particles of priming dust. Once the paint hits a dust particle, it sticks out like a sore thumb and ruins an otherwise perfect paint job. The Super Ion Air Knife neutralizes the charge and blows the dust away. To minimize compressed air use for these applications, we recommend the use of an **EXAIR EFC Electronic Flow Control** (see page 7) that automatically turns off the compressed air when no part is present.

Super Ion Air Knife Models

Super Ion Air Knife - includes the Super Air Knife and Ionizing Bar assembly.

Super Ion Air Knife Systems - include a Super Ion Air Knife and Model 7901 Power Supply (115V, 50/60 Hz).

Super Ion Air Knife Kits - include a Super Ion Air Knife, Model 7901 Power Supply, shim set, filter separator and pressure regulator (with coupler).

Deluxe Super Ion Air Knife Kits - include a Super Ion Air Knife, Model 7901 Power Supply, EFC, Universal Mounting System, shim set, filter separator and pressure regulator (with coupler).

Length	Super Ion Air Knife Model	Super Ion Air Knife Systems Model	Super Ion Air Knife Kits Model	Deluxe Super Ion Air Knife Kits Model
3" (76mm)	111003	111103	111203	111203DX
6" (152mm)	111006	111106	111206	111206DX
9" (229mm)	111009	111109	111209	111209DX
12" (305mm)	111012	111112	111212	111212DX
18" (457mm)	111018	111118	111218	111218DX
24" (610mm)	111024	111124	111224	111224DX
30" (762mm)	111030	111130	111230	111230DX
36" (914mm)	111036	111136	111236	111236DX
42" (1067mm)	111042	111142	111242	111242DX
48" (1219mm)	111048	111148	111248	111248DX
54" (1372mm)	111054	111154	111254	111254DX
60" (1524mm)	111060	111160	111260	111260DX
72" (1829mm)	111072	111172	111272	111272DX
84" (2134mm)	111084	111184	111284	111284DX
96" (2438mm)	111096	111196	111296	111296DX
108" (2743mm)	1110108	1111108	1112108	1112108DX



Kits include the Super Ion Air Knife, shim set, Model 7901 Power Supply, filter separator and pressure regulator (with coupler).

Universal Air Knife Mounting System

EXAIR's Universal Air Knife Mounting System allows easy positioning of all EXAIR Air Knives. See page 24 for details.



Long Super Ion Air Knives

EXAIR offers Long Super Ion Air Knives with Plumbing Kits in 60" (1524mm), 72" (1829mm), 84" (2134mm), 96" (2438mm) and 108" (2743mm) lengths that are shipped fully assembled. All components have been properly sized to obtain the best performance from the Super Ion Air Knife.

Super Ion Air Knife Models with Plumbing Kit

Long Super Ion Air Knife with Plumbing Kit - includes Super Air Knife, plumbing kit, and Ionizing Bar installed.

Long Super Ion Air Knife Systems with Plumbing Kit - includes Super Air Knife, plumbing kit, and Ionizing Bar installed. Includes Model 7901 Power Supply (115V, 50/60Hz).

Long Super Ion Air Knife Kits with Plumbing Kit - includes Super Air Knife, plumbing kit, and Ionizing Bar installed. Includes Model 7901 Power Supply (115V, 50/60Hz), shim set, filter separator, and pressure regulator (with coupler).

Length	Long Super Ion Air Knife Model	Long Super Ion Air Knife Systems Model	Long Super Ion Air Knife Kits Model
60" (1524mm)	111060PKI	111160PKI	111260PKI
72" (1829mm)	111072PKI	111172PKI	111272PKI
84" (2134mm)	111084PKI	111184PKI	111284PKI
96" (2438mm)	111096PKI	111196PKI	111296PKI
108" (2743mm)	1110108PKI	1111108PKI	1112108PKI

Accessories and Components

Model #	Description
7003	3" (76mm) Ionizing Bar Only
7006	6" (152mm) Ionizing Bar Only
7009	9" (229mm) Ionizing Bar Only
7012	12" (305mm) Ionizing Bar Only
7018	18" (457mm) Ionizing Bar Only
7024	24" (610mm) Ionizing Bar Only
7030	30" (762mm) Ionizing Bar Only
7036	36" (914mm) Ionizing Bar Only
7042	42" (1067mm) Ionizing Bar Only
7048	48" (1219mm) Ionizing Bar Only
7054	54" (1372mm) Ionizing Bar Only
7060	60" (1524mm) Ionizing Bar Only
7072	72" (1829mm) Ionizing Bar Only
7084	84" (2134mm) Ionizing Bar Only
7096	96" (2438mm) Ionizing Bar Only
70108	108" (2743mm) Ionizing Bar Only
7901	2 Outlet Power Supply (115V, 50/60Hz)
7907	2 Outlet Power Supply (230V, 50/60Hz)
7940	4 Outlet Power Supply (115V, 50/60Hz)
7941	4 Outlet Power Supply (230V, 50/60Hz)
7902	Extension Cable, 5' (1.52m) length
7905	Static Meter
9001	Auto Drain Filter Separator, 3/8 NPT, 65 SCFM (1,841 SLPM)
9032	Auto Drain Filter Separator, 1/2 NPT, 90 SCFM (2,549 SLPM)
9002	Auto Drain Filter Separator, 3/4 NPT, 220 SCFM (6,230 SLPM)
9066	Auto Drain Filter Separator, 1-1/4 NPT, 400 SCFM (11,327 SLPM)
9005	Oil Removal Filter, 3/8 NPT, 15-37 SCFM (425-1,048 SLPM)
9006	Oil Removal Filter, 3/4 NPT, 50-150 SCFM (1,416-4,248 SLPM)
9008	Pressure Regulator with Gauge, 1/4 NPT, 50 SCFM (1,416 SLPM)
9033	Pressure Regulator with Gauge, 1/2 NPT, 100 SCFM (2,832 SLPM)
9009	Pressure Regulator with Gauge, 3/4 NPT, 220 SCFM (6,230 SLPM)
9067	Pressure Regulator with Gauge, 1-1/4 NPT, 600 SCFM (16,990 SLPM)
9020	Solenoid Valve, 120V, 50/60Hz, 1/4 NPT, 40 SCFM (1,133 SLPM)
9034	NEMA 4/4X Solenoid Valve, 120V, 50/60Hz, 1/2 NPT, 100 SCFM (2,832 SLPM)
9035	NEMA 4/4X Solenoid Valve, 240V, 50/60Hz, 1/2 NPT, 100 SCFM (2,832 SLPM)
9036	NEMA 4/4X Solenoid Valve, 120V, 50/60Hz, 3/4 NPT, 200 SCFM (5,664 SLPM)
9037	NEMA 4/4X Solenoid Valve, 240V, 50/60Hz, 3/4 NPT, 200 SCFM (5,664 SLPM)
9065	NEMA 4/4X Solenoid Valve, 24VDC, 50/60Hz, 1 NPT, 350 SCFM (9,911 SLPM)

Static Eliminators

GO GREEN

SAVE MONEY

Order EXAIR's EFC™ electronic flow control to minimize compressed air use. See page 7 for details.



Special length Super Ion Air Knives and unlimited system lengths are available. Please contact our factory.



This 96" Long Super Ion Air Knife cleans an acrylic sheet before protective wrap is applied.

Standard Ion Air Knife™

A sheet of ionized air is an effective way to eliminate static and clean parts or materials!



What Is The Standard Ion Air Knife?

EXAIR's Standard Ion Air Knife is an effective way to eliminate static. Like its "super" counterpart, the Standard Ion Air Knife removes static electricity from plastics, webs, sheet stock and other surfaces where tearing, jamming or hazardous shocks are a problem.

This ionizer uses our original Standard Air Knife to carry ions from an ionizing bar to the charged surface - up to 20 feet (6.1m) away. Though not as efficient as our Super Ion Air Knife (40:1 air amplification), the Standard Ion Air Knife (30:1 air amplification) still provides fast static decay and strong blowoff force for cleaning. Force can be adjusted from a "blast" to a "breeze". The Standard Ion Air Knife is electrically powered, is shockless and has no moving parts.

Static
Eliminators

Why The Standard Ion Air Knife?

When air consumption and noise level are not critical to the application, the lower cost makes the Standard Ion Air Knife a good choice. (To compare the Super Ion Air Knife and Standard Ion Air Knife, see the performance tables on pages 97 and 103.)

Compressed air inlets are provided on each end of the Standard Ion Air Knife. For long spans, multiple Standard Ion Air Knives can be mounted end-to-end. This produces an air gap at the connection end of about 2" (51mm). (If no air gap is desired, use the Super Ion Air Knife.) Special length Ionizing Bars up to 119" (3.02m) are available for multiple air knife applications.



The Model 7218 18" (457mm) Standard Ion Air Knife System showers parts with static eliminating ions to prevent personnel shocks.

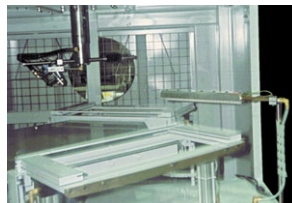

A Model 7212 12" (305mm) Standard Ion Air Knife System cleans metal frames prior to powder coating.

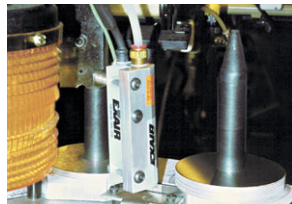

A Model 7103 3" (76mm) Standard Ion Air Knife removes dust from computer hard disks prior to assembly.

Applications

- Web cleaning
- Molding machinery
- Sheeters and trimmers
- Cleaning parts
- Pre-paint dust removal
- Shrink wrappers
- Package cleaning
- Bag opening/fill operations
- Printing equipment

Advantages

- Reduced air consumption
- 30:1 air amplification
- Low noise level
- Effective up to 20 feet (6.1m)
- Shockless, non-radioactive
- Compact, rugged, easy to install
- Unlimited system lengths
- Low maintenance
- Variable force and flow

Standard Ion Air Knife Performance

Pressure Supply		Air Consumption*		Sound Level	Dissipates 5kV**
PSIG	BAR	SCFM	SLPM	dBA	SECONDS
5	0.3	6	170	66	0.55
10	0.7	8	227	68	0.40
20	1.4	16	453	69	0.25
40	2.8	24	679	78	0.20
60	4.1	32	906	84	0.18
80	5.5	41	1,160	87	0.18
100	6.9	49	1,387	90	0.18

* per foot (305mm) of length ** 6" (152mm) from target.
For airflow pattern, see Standard Air Knife page 30.
Note: Performance on lengths over 36" will vary.
Contact an Application Engineer for details.



Kits include the Standard Ion Air Knife, shim set, Model 7901 Power Supply, filter separator and pressure regulator (with coupler).

Standard Ion Air Knife Models

Standard Ion Air Knife - consists of the Standard Air Knife and Ionizing Bar assembly. Does not include Power Supply.

Standard Ion Air Knife Systems - include a Standard Ion Air Knife and Model 7901 Power Supply (115V, 50/60Hz).

Standard Ion Air Knife Kits - include a Standard Ion Air Knife, Model 7901 Power Supply, shim set, filter separator and pressure regulator (with coupler).

Deluxe Standard Ion Air Knife Kits - include a Standard Ion Air Knife, EFC, Universal Mounting System, Model 7901 Power Supply, shim set, filter separator and pressure regulator (with coupler).

Length	Standard Ion Air Knife Model	Standard Ion Air Knife Systems Model	Standard Ion Air Knife Kits	Deluxe Standard Ion Air Knife Kits
3" (76mm)	7103	7203	7403	7403DX
6" (152mm)	7106	7206	7406	7406DX
9" (229mm)	7109	7209	7409	7409DX
12" (305mm)	7112	7212	7412	7412DX
18" (457mm)	7118	7218	7418	7418DX
24" (610mm)	7124	7224	7424	7424DX
30" (762mm)	7130	7230	7430	7430DX
36" (914mm)	7136	7236	7436	7436DX
42" (1067mm)	7142	7242	7442	7442DX
48" (1219mm)	7148	7248	7448	7448DX

Standard Ion Air Knife Specifications

The Standard Ion Air Knife is available in standard lengths of 3", 6", 9", 12", 18", 24", 30", 36", 42" and 48" (76, 152, 229, 305, 457, 610, 762, 914, 1067 and 1219mm). **Special lengths up to 48" (1219mm) and unlimited system lengths are available (please contact our factory).**

A 5' (1.52m) shielded power cable with ground and assembled bayonet connector are included.

EXAIR Model 7901, 7907, 7940 or 7941 Power Supply (5kV) is required for bar operation.

See page 115 for details.

Certifications: Ionizing Bars are UL Component Recognized to U.S. and Canadian safety standards. Power supplies are UL Listed to U.S. and Canadian safety standards, and are CE and RoHS compliant. **Compressed Air:** 1/4 NPT inlets are provided on each end.

Electrical: For use with 5 kVrms, 5 milliamperes (max.) power supply.

Electrical Hazard: Ionizing Bars are shockless (less than 40 microamperes short circuited).

Do not use near flammable materials or gases.

Materials of Construction:

Metal Parts: Aluminum

Plastic Parts: UL rated 94 HB

Emitters: Stainless Steel

Maximum Ambient Temperature: 165°F (74°C)

Shims: Thicker shims can be installed easily if additional hard-hitting velocity is required, see "shim sets" page 29.

Special length Standard Ion Air Knives and unlimited system lengths are available. Please contact our factory. See Accessories and Components on page 101.

Universal Air Knife Mounting System

EXAIR's Universal Air Knife Mounting System allows easy positioning of all EXAIR Air Knives. See page 24 for details.



Order EXAIR's EFC™ electronic flow control to minimize compressed air use. See page 7 for details.



Ionizing Bars

Low cost Ionizing Bars eliminate static cling!

Compact, rugged design for industrial applications!



What Is The Ionizing Bar?

EXAIR's Ionizing Bar eliminates static electricity on paper, film and plastics that can attract dust and foreign materials, ruin product appearance, produce tearing or jamming, and zap personnel. The electrically powered Ionizing Bar is compact, allowing it to fit in the confined spaces of machinery, where the charge is generated. A high concentration of positive and negative ions produce fast static decay, neutralizing any surface within 2" (51mm) of the bar.

Why The Ionizing Bar?

The unique design of the shockless Ionizing Bar offers improved performance and reliability in industrial applications. Life expectancy has been extended by insertion molding the stainless steel ion emitters into a durable plastic. There are no openings or grooves to accumulate dirt that could cause shorting or arcing. A 5kV power source provides high performance, eliminating frequent burnouts commonly associated with traditional 7kV bars.

The Ionizing Bar includes a five foot shielded cable with ground. A mounting flange is provided for easy installation and all components are fully assembled. Standard lengths up to 108" (2743mm) are available from stock and special lengths up to 119" (3.02m) are available by special order. EXAIR Model 7901, 7907, 7940 or 7941 Power Supply (5kV) is required for bar operation.

The ability to eliminate static can be greatly improved when attaching the Super Air Knife to the Ionizing Bar (see *Super Ion Air Knife*, page 96). The Super Ion Air Knife propels the static neutralizing ions over a larger area which is ideal for high speed, high charge applications. Air delivery can also remove dust and clean the product surface.

Applications

- Labeling
- Bag making - form and fill
- Neutralizing shrink wrap
- Sheet fed and web presses
- Packaging
- Converting machinery
- Neutralizing slitting operations
- Textiles
- Screen printing

Advantages

- Low cost
- Rapid static decay
- Compact
- Effective up to 2" (51mm)
- Shockless, non-radioactive
- Rugged design for industrial environments
- Easy to install, equipped with mounting flange
- Low maintenance
- Fully assembled

How The Ionizing Bar Works

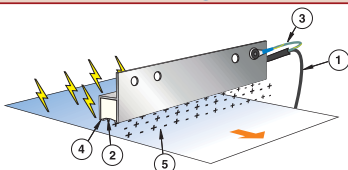

The shielded power cable (1) carries the 5kVrms power supply output to each capacitively coupled stainless steel emitter point (2) of the Ionizing Bar. A ground wire (3) attached to the bar creates a discharge path from the emitter points to the bar channel (4). The discharge at each emitter charges the molecules of the gases of the surrounding room air, resulting in a shower of ions that are positively and negatively charged (5). If the material surface has a negative charge, it will attract the positive ions from the ionizing bar and become balanced or neutralized. If the material surface has a positive charge, it will attract the negative ions from the ionizing bar to become balanced or neutralized. The voltage potential at each emitter is high enough to ionize the surrounding air without generating a shock when any of the emitters are touched.

Ionizing Bars

Ionizing Bars - include a 5' (1.52m) length of shielded cable and assembled connector. For other cable lengths, please contact the factory.

Length	Ionizing Bar Models
3" (76mm)	7003
6" (152mm)	7006
9" (229mm)	7009
12" (305mm)	7012
18" (457mm)	7018
24" (610mm)	7024
30" (762mm)	7030
36" (914mm)	7036
42" (1067mm)	7042
48" (1219mm)	7048
54" (1372mm)	7054
60" (1524mm)	7060
72" (1829mm)	7072
84" (2134mm)	7084
96" (2438mm)	7096
108" (2743mm)	70108

Ionizing Bar Specifications

EXAIR Model 7901, 7907, 7940 or 7941 Power Supply (5kV) is required for bar operation. See page 115 for details.

Certifications: Ionizing Bars are UL Component Recognized to U.S. and Canadian safety standards. Power supplies are UL Listed to U.S. and Canadian safety standards, and are CE and RoHS compliant.

Electrical: For use with 5 kVrms, 5 milliamperes (max.) power supply.

Electrical Hazard: Ionizing Bars are shockless (less than 40 microamperes short circuited).

Do not use near flammable materials or gases.

Materials of Construction:

Metal Parts: Aluminum

Plastic Parts: UL rated 94 HB

Emitters: Stainless Steel

Maximum Ambient Temperature: 165°F (74°C)

Ionizing Bar Performance

	Distance From Charged Surface		
	0.50" (13mm)	1" (25mm)	2" (51mm)
Dissipates 5kV* (seconds)	0.12	0.18	0.30

* Model 7006 6" (152mm) Ionizing Bar tested

Ionizing Bar Dimensions

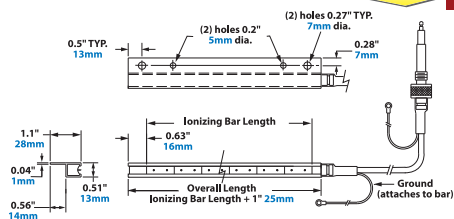

Accessories and Components

Model #	Description
7901	2 Outlet Power Supply (115V, 50/60Hz)
7907	2 Outlet Power Supply (230V, 50/60Hz)
7940	4 Outlet Power Supply (115V, 50/60Hz)
7941	4 Outlet Power Supply (230V, 50/60Hz)
7902	Extension Cable, 5' (1.52m) length
7905	Static Meter



Model 7906 6" (152mm) Ionizing Bar and Model 7901 Power Supply.

Special length Ionizing Bars up to 119" (3.02m) are available. Please contact our factory.

Super Ion Air Wipe™

Ring of ionized airflow clamps around the part!

Neutralizes and cleans continuous moving surfaces!

What Is The Super Ion Air Wipe?

EXAIR's Super Ion Air Wipe provides a uniform 360° ionized airstream that is easy to clamp around a part for eliminating static electricity and contaminants. It is ideal for use on pipe, cable, extruded shapes, hose, wire and more. It maximizes ionized airflow while minimizing compressed air consumption.

Why The Super Ion Air Wipe?

The Super Ion Air Wipe provides total coverage of the part moving through it. The high volume, high velocity flow attaches itself to the surface and wipes it down with the static eliminating ions. The airflow stays attached to the surface and is effective up to 15' (4.6m) away from where the Super Ion Air Wipe is mounted. An optional pressure regulator provides infinite control of the air volume and velocity. Increasing the pressure increases the forceful wiping action. Lower pressures provide excellent coverage with much lower force and velocity.

The Super Ion Air Wipe is the easy way to provide uniform coverage around a continuously moving material. The hinged design, allowing the Air Wipe to open, makes threading continuous wire, tube or extrusions unnecessary. Arranging a series of other ionizers around the surface would provide uneven airflow and prove to be costly. The split design of the Super Ion Air Wipe solves that problem by making it easy to clamp around the surface of the material moving through it, eliminating the need for threading or several ionizers.

The Super Ion Air Wipe is lightweight and easy to mount using the tapped holes on the back. It can also be held in place with rigid pipe. Coupling brackets that hold each half of the Super Ion Air Wipe together are provided which can be installed or removed quickly if required.

Applications

- Clean and neutralize extrusions
- Neutralizing pipe, tubing, wire
- Cleaning molded parts
- Neutralizing static for quality printing
- Pre-paint dust removal
- Remove chips, shavings and sawdust
- Container neutralization

Advantages

- Low air consumption
- Rapid static decay
- Quiet
- Shockless, non-radioactive
- Compact, rugged, easy to install
- No moving parts - low maintenance
- Variable force and flow
- Electromagnetic shielded high voltage cable
- Armored high voltage cable protects against abrasion, cuts
- Integrated ground design requires no separate ground connection
- Replaceable emitter points

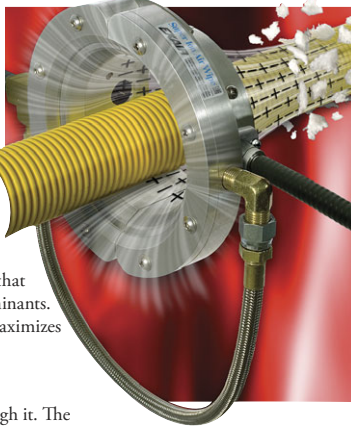

The split design unlatches easily to fit around the moving part - no threading required.



The Super Ion Air Wipe is available in a 2" (51mm) and 4" (102mm) diameter.

How The Super Ion Air Wipe Works

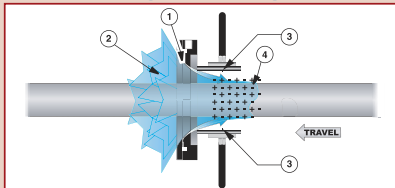

The Super Ion Air Wipe incorporates a Super Air Wipe and a split ionizing collar, energized by a power supply. Compressed air is ejected through the small ring nozzle of the Super Air Wipe at high velocity (1). A conical 360° ring of air is created that induces high volumes of surrounding air (2). The airflow passes through the collar and is ionized by two replaceable emitter points (3). That high velocity, ionized airstream attaches itself to the surface of the material running through the Super Ion Air Wipe (4), uniformly eliminating the static electricity and removing any contaminants from the surface.



Model 8462 Super Ion Air Wipe Kit includes the Super Ion Air Wipe, shim set, Model 7960 Power Supply, filter separator and pressure regulator (with coupler).

Super Ion Air Wipe

Model #	Description
8162	2" (51mm) Super Ion Air Wipe
8164	4" (102mm) Super Ion Air Wipe
8262	2" (51mm) Super Ion Air Wipe and Power Supply
8264	4" (102mm) Super Ion Air Wipe and Power Supply

Super Ion Air Wipe Kits

Kits include a Super Ion Air Wipe, shim set, Model 7960 Power Supply, filter separator and pressure regulator (with coupler).

Model #	Description
8462	2" (51mm) Super Ion Air Wipe Kit
8464	4" (102mm) Super Ion Air Wipe Kit

Accessories and Components

Kits include a Super Ion Air Wipe, shim set, Model 7960 Power Supply, filter separator and pressure regulator (with coupler).

Model #	Description
7960	2 Outlet Selectable Voltage Power Supply (115V, 230V, 50/60Hz)
9001	Auto Drain Filter Separator, 3/8 NPT, 65 SCFM (1,841 SLPM)
9008	Pressure Regulator with Gauge, 1/4 NPT, 50 SCFM (1,415 SLPM)
7905	Static Meter

Super Ion Air Wipe Specifications

EXAIR Model 7960 Power Supply (5kV) is required for operation. See page 115 for details.

Certifications: The Super Ion Air Wipe and Power Supply are UL Component Recognized to U.S. and Canadian safety standards, and are CE and RoHS compliant.



Electrical: For use with 5 kVrms, 5 milliamperes (max.) power supply.

Electrical Hazard: Shockless (less than 40 microamperes short circuited).

Do not use near flammable materials or gases.

Materials of Construction:

Metal Parts: Aluminum

Plastic Parts: UL rated 94 HB **Emitter:** Stainless Steel

Maximum Ambient Temperature: 165°F (74°C)

Shims: Thicker shims can be installed easily if additional hard-hitting velocity is required. See "shim sets" page 35.

Compressed Air: 1/4 NPT inlet provided.

Super Ion Air Wipe Performance

80 PSIG (5.5 BAR)	Air Consumption	Sound Level	Dissipates 5kV*	
MODEL	SCFM	SLPM	dBA	SECONDS
8162	29.5	835	77	0.20
8164	50.2	1,422	81	0.20

* 12" (305mm) from target.

Super Ion Air Wipe Dimensions

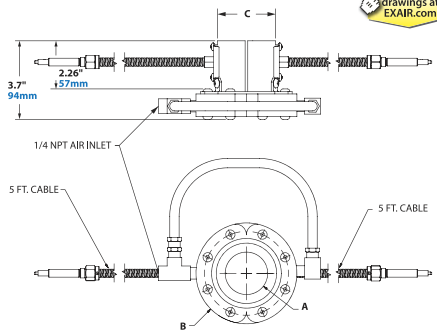

MODEL	A	B	C
8162	2" (51mm)	4.75" (121mm)	2.7" (69mm)
8164	4" (102mm)	6.75" (171mm)	4.7" (69mm)

Ion Air Cannon™

Quiet, efficient, concentrated flow of ionized air removes static and dust!



What Is The Ion Air Cannon?

EXAIR's Ion Air Cannon neutralizes static electricity and cleans at distances up to 15 feet (4.6m) with no moving parts. It is ideal for those hard to reach spaces or confined areas that require a concentrated flow of static eliminating ions. With an optional pressure regulator, the air volume and velocity are infinitely adjustable over a wide range, for light to heavy duty applications.

Why The Ion Air Cannon?

The Ion Air Cannon will **maximize ionized airflow while minimizing compressed air consumption**. A small amount of compressed air is used to entrain a high volume flow of surrounding air. This combined stream is ionized by an emitter point (shockless) and delivered to the charged surface. A hose or tube can be connected to the air intake of the Ion Air Cannon to draw quality air from another area. It requires only 10 PSIG (0.7 BAR) for most applications.

The compact design saves bench space and allows mounting in confined areas. The sturdy stand is pre-drilled and can be wall, bench or machine mounted. It incorporates a swivel adjustment for directing the airflow.

EXAIR's EFC (*shown on page 7*) is an electronic flow control for compressed air. For production lines, it can sense when no part is present and will automatically turn off the compressed air to the Ion Air Cannon until the next part moves into position.



The Model 8292 Ion Air Cannon System eliminates the static and dust prior to filling the bottles.



(3) Ion Air Cannons blow contaminants from car bodies prior to painting.

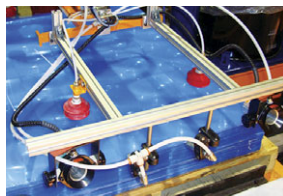

Model 8192 Ion Air Cannons provide static elimination in between solar panel lenses to assist separation of the lenses during production.

Static
Eliminators

Applications

- Bag opening - form and fill
- Clean and neutralize parts
- Neutralizing shrink wrap
- Cleaning molded parts
- Removing static on assemblies
- Pre-paint dust removal
- Neutralizing slitting operations
- Package cleaning
- Container neutralization

Advantages

- Electromagnetic shielded high voltage cable
- Armored high voltage cable protects against abrasion, cuts
- Integrated ground design requires no separate ground connection
- Replaceable emitter point
- Low air consumption
- Rapid static decay
- Quiet
- Shockless, non-radioactive
- Compact, rugged, easy to install
- Intake can be ducted
- No moving parts - low maintenance
- Variable force and flow

How The Ion Air Cannon Works

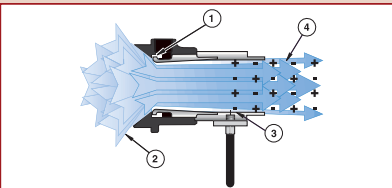

The Ion Air Cannon incorporates a Super Air Amplifier* and ionizing collar, energized by a power supply. A small amount of compressed air is injected into the barrel of the cannon (1) inducing a high volume flow of surrounding air to flow through it (2). A replaceable emitter point at the discharge end of the cannon (3) ionizes the entire airstream. The result is a high volume, conical flow of ionized air (4) capable of eliminating static and cleaning at distances up to 15 feet (4.6m). Because more than 90% of the ionized air is induced, the **Ion Air Cannon produces maximum airflow at minimum air consumption.**

* Patent #5402938



Model 8492 Ion Air Cannon Kit includes the Ion Air Cannon, shim set, Model 7960 Power Supply, filter separator and pressure regulator (with coupler).

Ion Air Cannon

Model # Description

8192	Ion Air Cannon includes Super Air Amplifier, Emitter, Stand, and 5' (1.52m) length of armored and electromagnetically shielded cable
8292	Ion Air Cannon and Power Supply
8492	Ion Air Cannon Kit (see image above)

Deluxe Ion Air Cannon Kits

Model # Description

8492DX	Kits include an Ion Air Cannon, EFC, shim set, Model 7960 Power Supply, filter separator and pressure regulator (with coupler).
--------	---

Accessories and Components

Model # Description

7960	2 Outlet Selectable Voltage Power Supply (115V, 230V, 50/60Hz)
9001	Auto Drain Filter Separator, 3/8 NPT, 65 SCFM (1,841 SLPM)
9008	Pressure Regulator with Gauge, 1/4 NPT, 50 SCFM (1,416 SLPM)
7905	Static Meter

Ion Air Cannon Specifications

EXAIR Model 7960 Power Supply (5kV) is required for operation. See page 115 for details.

Certifications: The Ion Air Cannon and Power Supply are UL Component Recognized to U.S. and Canadian safety standards, and are CE and RoHS compliant.



Electrical: For use with 5 kVrms, 5 milliamperes (max.) power supply.

Electrical Hazard: Shockless (less than 40 microamperes short circuited).

Do not use near flammable materials or gases.

Materials of Construction:

Metal Parts: Aluminum

Plastic Parts: UL rated 94 HB **Emitter:** Stainless Steel

Maximum Ambient Temperature: 165°F (74°C)

Shims: Thicker shims can be installed easily if additional hard-hitting velocity is required. See page 44.

Compressed Air: 3/8 NPT inlet provided.

Ion Air Cannon Performance

Pressure Supply	Air Consumption	Sound Level	Dissipates 5kV*		
PSIG	BAR	SCFM	SLPM	dBA	SECONDS
20	1.4	5.7	161	58	0.75
40	2.8	9	255	64	0.6
60	4.1	12.2	345	70	0.5
80	5.5	15.5	439	72	0.43
100	6.9	18.7	529	74	0.37

* 12" (305mm) from target. For airflow pattern, see Super Air Amplifier on page 44.

Ion Air Cannon Dimensions

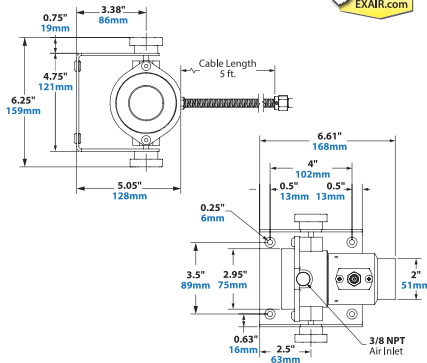

How The Ion Air Gun Works

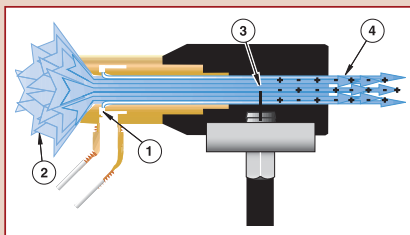

The Ion Air Gun incorporates a High Velocity Air Jet and electrically energized emitter point. A small amount of compressed air is injected into the air jet (1) inducing high volume flow of surrounding air (2) to pass through it.

The emitter point (shockless) at the discharge end of the gun (3) ionizes the entire airstream. **The result is a high volume flow of ionized air (4) capable of neutralizing high static charges in fractions of a second.** An optional filter and regulator clean the compressed air and allow infinite adjustment of airflow and velocity.

Ion Air Gun Performance

Pressure Supply		Air Consumption		Sound Level	Dissipates 5kV*
PSIG	BAR	SCFM	SLPM	dBA	SECONDS
20	1.4	7.4	209	67	0.45
40	2.8	11.5	325	74	0.33
60	4.1	15.8	447	79	0.24
80	5.5	22.0	622	82	0.18
100	6.9	24.0	679	85	0.18

* 6" (152mm) from target. For airflow pattern, see Model 6013 High Velocity Air Jet on page 56.



Model 8493 Ion Air Gun Kit includes the Ion Air Gun, Model 7960 Power Supply, filter separator and pressure regulator (with coupler).

Order Direct
We Ship From Stock

Ion Air Gun Specifications

EXAIR Model 7960 Power Supply (5kV) is required for operation. See page 115 for details.

Certifications: The Ion Air Gun and Power Supply are UL Component Recognized to U.S. and Canadian safety standards, and are CE and RoHS compliant.



Electrical: For use with 5 kVrms, 5 milliamperes (max.) power supply.

Electrical Hazard: Shockless (less than 40 microamperes short circuited).

Do not use near flammable materials or gases.

Materials of Construction:

Metal Parts: Brass, Zinc and Stainless Steel

Plastic Parts: UL rated 94 HB **Emitter:** Stainless Steel

Maximum Ambient Temperature: 165°F (74°C)

Compressed Air: 1/4 NPT inlet provided.



Static Eliminators

80% of the delivered air is induced, minimizing air consumption of the Ion Air Gun.

Ion Air Gun

Model #	Description
8193	Ion Air Gun Only includes 10' (3m) shielded cable*
8293	Ion Air Gun and Power Supply
8493	Ion Air Gun Kit includes the Ion Air Gun, Model 7960 Power Supply, filter separator and pressure regulator (with coupler).

* For special length cables, please contact the factory.

Accessories and Components

Model #	Description
7960	2 Outlet Selectable Voltage Power Supply (115V, 230V, 50/60Hz)
9001	Auto Drain Filter Separator, 3/8 NPT, 65 SCFM (1,841 SLPM)
9005	Oil Removal Filter, 3/8 NPT, 15-37 SCFM (425-1,048 SLPM)
9008	Pressure Regulator with Gauge, 1/4 NPT, 50 SCFM (1,416 SLPM)
7905	Static Meter

Ion Air Jet™

Air saving Ion Air Jet is an effective spot cleaner!

Choose permanent mount or flexible hose with base!

What Is The Ion Air Jet?

EXAIR's Ion Air Jet delivers a concentrated airflow that can cover a precise spot without disturbing other areas. This quiet, focused airstream provides incredibly fast static decay rates and cleaning ability. The Ion Air Jet is the ideal way to remove static and dust from small parts prior to shrink wrapping, packaging, printing, painting or finishing.

Why The Ion Air Jet?

The Ion Air Jet induces surrounding airflow at a ratio of 5:1, minimizing compressed air use and maximizing ionized airflow. Force can be adjusted from a "blast" to a "breeze".

Your Choice Of Permanent Mount or Flexible Stay Set Hose™

For permanent mount applications, the compact Ion Air Jet is the best choice since it is lightweight and easy to install using the 1/8 NPT male inlet. For applications where frequent repositioning is required, the flexible Stay Set Ion Air Jet™ is ideal. This version can be placed in close proximity and the hose bent to aim the ionized airstream at the localized area. Since the hose has "memory" it will not creep or bend, always keeping the aim until physically moved to the next position.

The Stay Set Ion Air Jet comes complete with a magnetic base that allows easy mounting and portability on a machine, a bench or other surface. A shutoff valve on the base provides infinite control of the force and flow. For hands free operation, an optional Model 9040 Foot Pedal (requires floor or machine mounting) is available.

Applications

- Three dimensional parts
- Bottle cleaning
- Screen printing
- Shrink bands
- Ink jet printing
- Part cleaning
- Package cleaning

Advantages

- Low cost
- Rapid static decay
- Quiet
- Shockless, non-radioactive
- Electromagnetic shielded high voltage cable
- Armored high voltage cable protects against abrasion, cuts
- Integrated ground design requires no separate ground connection
- Replaceable emitter point
- Compact, rugged, easy to install
- Stay Set Hose for accurate placing
- Low air consumption

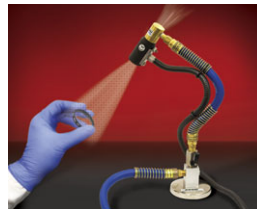

The Model 8194-9362 Stay Set Ion Air Jet Kit cleans dust from a glass lens prior to installation on a gauge.



The Model 8294 Ion Air Jet with Power Supply neutralizes and cleans mouthwash bottles before heat shrinking the tamper-proof seal.



The Model 8910 Instant Static Elimination Station removes contaminants on plastic fittings prior to packaging.

How The Ion Air Jet Works

The Ion Air Jet functions the same as the Ion Air Gun without the blowgun handle. For details on how it works, see page 111 “*How The Ion Air Gun Works*”.

Ion Air Jet Performance

Pressure Supply		Air Consumption		Sound Level	Dissipates 5KV*
PSIG	BAR	SCFM	SLPM	dBA	SECONDS
20	1.4	7.4	209	67	0.45
40	2.8	11.5	325	74	0.33
60	4.1	15.8	447	79	0.24
80	5.5	22.0	622	82	0.18
100	6.9	24.0	679	85	0.18

* 6" (152mm) from target. For airflow pattern, see Model 6013 High Velocity Air Jet on page 56.

Ion Air Jet Dimensions

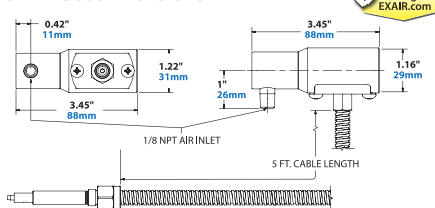

Ion Air Jet

Model #	Description
8194	Ion Air Jet Only includes 5' (1.52m) armored and electromagnetic shielded cable*
8294	Ion Air Jet and Power Supply
8494	Ion Air Jet Kit includes Power Supply, filter separator and pressure regulator (with coupler).

Stay Set Ion Air Jet

Model #	Description
8194-9362	Stay Set Ion Air Jet includes 5' (1.52m) armored and electromagnetic shielded cable*, one outlet magnetic base with shut-off valve, and 12" (305mm) Stay Set Hose.
8294-9362	Stay Set Ion Air Jet and Model 7960 Power Supply (115V, 50/60Hz)
8494-9362	Stay Set Ion Air Jet Kit (see detail at right)
8495-9362	Deluxe Stay Set Ion Air Jet Kit (see detail at right)
8910	Instant Static Elimination Station (see detail at right)

* For special length cables, please contact the factory.

Accessories and Components

Model #	Description
7960	2 Outlet Selectable Voltage Power Supply (115V, 230V 50/60Hz)
9001	Auto Drain Filter Separator, 3/8 NPT, 65 SCFM (1,841 SLPM)
9008	Pressure Regulator with Gauge, 1/4 NPT, 50 SCFM (1,416 SLPM)
9040	Foot Pedal, 1/4 NPT, 60 SCFM (1,698 SLPM)
7905	Static Meter

Ion Air Jet Specifications

EXAIR Model 7960 Power Supply (5kV) is required for operation. See page 115 for details.

Certifications: The Ion Air Jet and Power Supply are UL Component Recognized to U.S. and Canadian safety standards, and are CE and RoHS compliant.



Electrical: For use with 5 kVrms, 5 milliamperes (max.) power supply.

Electrical Hazard: Shockless (less than 40 microamperes short circuited).

Do not use near flammable materials or gases.

Materials of Construction:

Metal Parts: Brass and Stainless Steel

Plastic Parts: UL rated 94 HB

Emitter: Stainless Steel

Maximum Ambient Temperature: 165°F (74°C)

Compressed Air: 1/8 NPT inlet provided on Ion Air Jet.

1/4 NPT inlet provided on Stay Set Ion Air Jet.



Model 8494 Ion Air Jet Kit includes the Ion Air Jet, Model 7960 Power Supply, filter separator and pressure regulator (with coupler).



Model 8494-9362 Stay Set Ion Air Jet Kit includes the Stay Set Ion Air Jet, Model 7960 Power Supply, filter separator and pressure regulator (with coupler).



Model 8910 Instant Static Elimination Station includes the Stay Set Ion Air Jet, Model 7960 Power Supply, foot pedal and (2) 10' (3m) hoses.



Model 8495-9362 Deluxe Stay Set Ion Air Jet Kit includes the Stay Set Ion Air Jet, Model 7960 Power Supply, filter separator and pressure regulator (with coupler), foot pedal and 10' (3m) hose.

Static Eliminators

Ionizing Point™

Single point ionizer for spot neutralization!

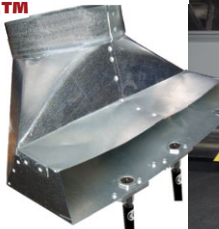

The Ionizing Point can be machine or duct mounted.

What Is The Ionizing Point?

EXAIR's Ionizing Point is a compact, single point ionizer ideal for winding, rewinding or slitting operations. It can also be mounted through a duct to neutralize static charges due to moving air or materials.

The shockless Ionizing Point delivers a high concentration of positive and negative ions for fast static decay. It can neutralize any surface within 2" (51mm).

Ionizing Point Dimensions

DOWNLOAD Drawings at EXAIR.com

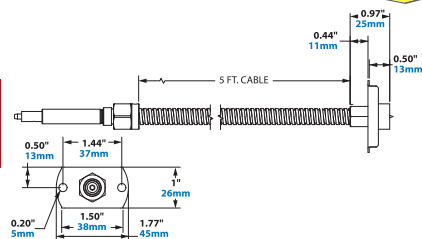

Ionizing Point Performance

	Distance From Charged Surface		
	0.50" (13mm)	1" (25mm)	2" (51mm)
Dissipates 5kV (seconds)	0.12	0.18	0.24

Applications

- Winding
- Rewinding
- Slitting
- Neutralizing ducted air

Advantages

- Low cost
- Electromagnetic shielded high voltage cable
- Armored high voltage cable protects against abrasion, cuts
- Integrated ground design requires no separate ground connection
- Replaceable emitter point
- Rapid static decay
- Shockless
- Non-radioactive
- Compact

Ionizing Point Specifications

EXAIR Model 7960 Power Supply (5kV) is required for operation. See page 115 for details.

Certifications: The Ionizing Point and Power Supply are UL Component Recognized to U.S. and Canadian safety standards, and are CE and RoHS compliant.

Electrical: For use with 5 kVrms, 5 milliamperes (max.) power supply.

Electrical Hazard: Shockless (less than 40 microamperes short circuited).

Do not use near flammable materials or gases.

Materials of Construction:

- Metal Parts: Stainless Steel
- Plastic Parts: UL rated 94 HB
- Emitter: Stainless Steel

Maximum Ambient Temperature: 165°F (74°C)



The Model 8299 Ionizing Point System includes the Ionizing Point and Model 7960 Power Supply.

Ionizing Point

Model #	Description
8199	Ionizing Point Only includes 5' (1.52m) shielded cable*
8299	Ionizing Point System (see detail above)

* For special length cables, please contact the factory.

Accessories and Components

Model #	Description
7960	2 Outlet Selectable Voltage Power Supply (115V, 230V, 50/60Hz)
7905	Static Meter

Power Supplies

Single Voltage: For use with Super Ion Air Knife Standard Ion Air Knife, and Ionizing Bars



The Model 7901 and 7907 Power Supplies have a lighted power switch and (2) 5kV outlets.

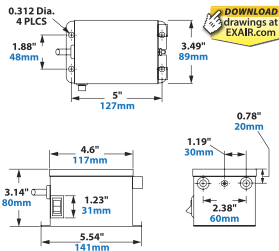

The two and four outlet Power Supplies require an input of 115 VAC, 50/60 Hz. Two other variations for 230 VAC are also available. A 6' (1.83m) power cord and lighted power switch are included. Power Supplies are UL Listed to U.S. and Canadian safety standards, and are CE and RoHS compliant.



The Model 7940 and 7941 Power Supplies have a lighted power switch and (4) 5kV outlets.

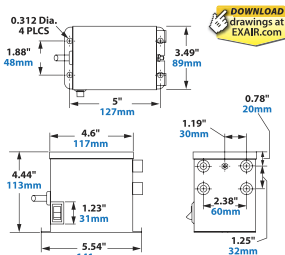

Power Supplies: Single Voltage

Model #	Description
7901	2 Outlet Power Supply (115V, 50/60Hz)
7907	2 Outlet Power Supply (230V, 50/60Hz)
7940	4 Outlet Power Supply (115V, 50/60Hz)
7941	4 Outlet Power Supply (230V, 50/60Hz)

Static Eliminators

Power Supplies

Selectable Voltage: For use with Ion Air Cannon, Ion Air Gun, Super Ion Air Wipe, Ion Air Jet and Ionizing Point



The Model 7960 Power Supply has switchable input voltage and modular cable.

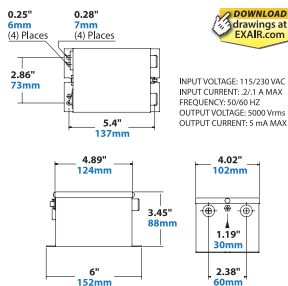

Selectable voltage Power Supplies allow you to choose the input voltages of 115 VAC or 230 VAC. The modular cable with electromagnetic shielding protects sensitive electronics against electromagnetic interference while easing connections and routing. An integrated fuse on the primary protects against voltage spikes. Power Supplies are UL Component Recognized to US and Canadian Standards, and are CE and RoHS compliant.



Advantages

- Replaceable rocker switch
- Durable, stainless steel high voltage connections
- Selectable voltage 115VAC or 230VAC
- Electromagnetic shielded modular power cable
- Fuse protects against voltage spikes

Power Supplies: Selectable Voltage

Model #	Description
7960	Selectable Voltage Power Supply, 2 outlet, (115V, 50/60Hz or 230V, 50/60Hz)